

Garronn-electronics.co.uk

PRICE 15/-



Assembling
and
Using Your...

Heathkit

**LABORATORY and
GENERAL PURPOSE
OSCILLOSCOPE**

**MODEL
O-12-U**

DAYSTROM LIMITED

A Subsidiary of the Daystrom Group,
Manufacturers of the world's finest
Electronic Equipment in Kit Form.

GLOUCESTER, ENGLAND

COLOUR CODE FOR FIXED RESISTORS - (B.S.1852-1952) COLOUR BAND MARKING

FIG1. (COLOURED BAND MARKING PREFERRED)

THIS EXAMPLE SHOWS
A GRADE I. RESISTANCE
OF $6,800 \Omega \pm 5\%$

BLUE (6)
GREY (8)
RED ($\times 10^2$)
GOLD ($\pm 5\%$)

{ SALMON PINK (GRADE I.)
THIS MAY BE GENERAL BODY COLOUR

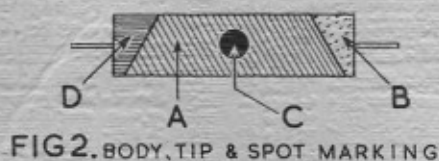
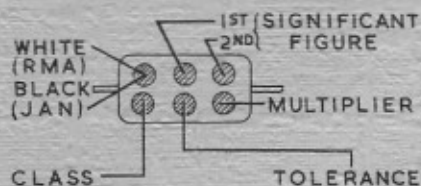

FIG3. BODY TIP & CENTRAL BAND MARKING



AMERICAN "RMA", "JAN" & COMMERCIAL CODING FOR MOULDED MICA CAPACITORS

CURRENT STANDARD CODE



MOULDED FLAT CAPACITOR
COMMERCIAL CODE

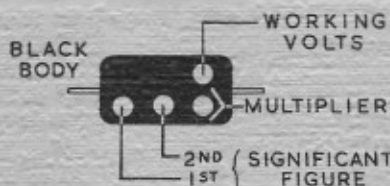

JAN. CODE CAPACITOR

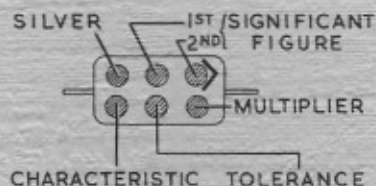

COLOUR CODE FOR RESISTORS AND CAPACITORS

Colour	Value in Ohms or pF for Cols. A, B & C.				COL. D. (TOLERANCE RATING)			CAPACITORS COL. E. TEMP. COEFFICIENT per 10^6 per $^{\circ}\text{C}$.
	COL. A. 1st Figure	COL. B. 2nd Figure	COL. C. (MULTIPLIER)		Resistors	Ceramic Capacitors		
			Resistors ohms	Capacitors pF		Up to 10 pF	Over 10 pF	
BLACK	-	0	1	1	-	2 pF	$\pm 20\%$	0
BROWN	1	1	10	10	$\pm 1\%$	0.1 pF	$\pm 1\%$	-30
RED	2	2	100	100	$\pm 2\%$	-	$\pm 2\%$	-80
ORANGE	3	3	1,000	1,000	-	-	$\pm 2.5\%$	-150
YELLOW	4	4	10,000	10,000	-	-	-	-220
GREEN	5	5	100,000	-	-	0.5 pF	$\pm 5\%$	-330
BLUE	6	6	1,000,000	-	-	-	-	-470
VIOLET	7	7	10,000,000	-	-	-	-	-750
GREY	8	8	100,000,000	.01	-	0.25 pF	-	+30
WHITE	9	9	1,000,000,000	.1	-	1 pF	$\pm 10\%$	+100
SILVER	-	-	.01	-	$\pm 10\%$	-	-	-
GOLD	-	-	.1	-	$\pm 5\%$	-	-	-
SALMON	-	-	-	-	-	-	-	-
PINK	-	-	-	-	-	-	-	-
NO "D"	-	-	-	-	-	-	-	-

COLOUR

The Colour coding should be read from left to right, in order, starting from the end and finishing near the middle.

Standard \pm tolerances for resistors are:- Wire-wound: 1%, 2%, 5%, 10%. Composition, Grade 1: 1%, 2%, 5%. Grade 2: 5%, 10%, 20%. (20% is indicated by 4th (or 'D') colour). Grade 1: ("high-stability") composition resistors are distinguished by a salmon-pink fifth ring or body colour. (Reference: B.S.1852: 1952 B.S.1.)

N. B. High-Stability Resistors supplied with this kit are not as a rule colour coded but enamelled in one colour on which the value in Ohms is printed in figures. Capacitors supplied in this kit usually have their capacity clearly marked in figures. Some Capacitors coded as above also have additional "voltage rating" coding.

Heathkit Laboratory Oscilloscope

MODEL O-12-U



SPECIFICATIONS

Vertical Channel:

Sensitivity.....	0.010 volts (RMS) per cm. at 1 kc.
Frequency Response.....	Flat within ± 1 dB from 8 cps, to 2.5 mc. Flat, +1.5 to -5 dB; 3 cps to 5 mc. Response at 3.58 mc, -2.2 dB. (All response measurements referred to 1 kc)
Rise Time.....	0.08 microseconds or less.
Overshoot.....	10% or less
Transient Response.....	Oscillograms below are unretouched displays of square wave signals. (Rise time of source generator was less than 0.02 microseconds.)

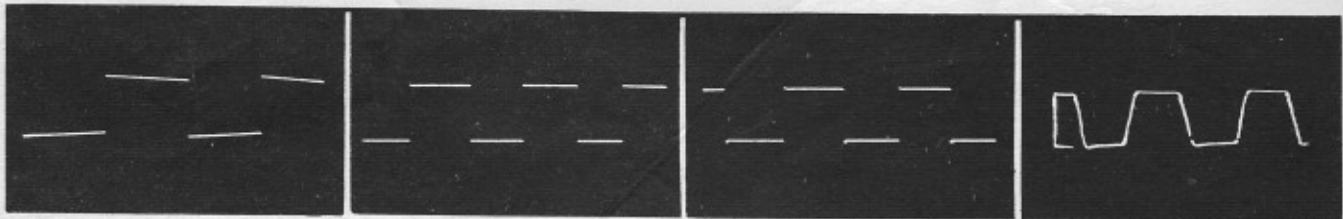

50 CPS

1000 CPS

100 KC

1 MC

Input Impedance.....	In X1 attenuator position, 2.9 megohms shunted by 21 pF. (1 kc impedance, 2.7 megohms) In X10 and X100 positions, 3.4 megohms shunted by 12 pF. (1 kc impedance, 3.3 megohms)
Attenuator.....	Three-position, switch-type, fully compensated; no visible change in wave shape at any attenuator setting.
Input Characteristics.....	Special low-capacity input terminal; built-in blocking capacitor rated at 600 volts DC.
Vertical Positioning.....	DC type; permits placement of undeflected trace at any horizontal level on usable area (± 4 cm. from centre) of screen; positioning is instantaneous and free of drift.

Horizontal Channel:

Sensitivity.....	0.120 volts (RMS) per cm. at 1 kc.
Frequency Response.....	Flat within ± 1 dB 1 cps to 200 kc. Flat within ± 3 dB 1 cps to 400 kc.
Input Impedance.....	30 megohms shunted by 31 pF. (1 kc impedance, 4.9 megohms)
Attenuator.....	Low impedance type in cathode follower output.
Input Characteristics.....	Selector switch permits use of external input through panel terminal, line-frequency sweep of variable phase or internal sweep from time base generator.
Horizontal Positioning.....	DC type; permits wide range of positioning to examine any part of trace even with full horizontal gain.

Time Base Generator:

Recurrent type.....	utilising Heath sweep circuit.
Range.....	10 cps to 500 kc in five steps: 10 to 100 cps, 100 to 1000 cps, 1 to 10 kc, 10 to 100 kc, 100 to 500 kc.
Synchronising.....	Automatic lock-in circuit, using self-limiting synchronising cathode follower. Holds sweep speed essentially independent of vertical gain settings. Selector switch permits synchronising with either positive or negative signal pulses internally, with external source through panel terminals or with mains frequency.
Time Base Output.....	A time base output terminal is provided for operation of the oscilloscope in conjunction with frequency-swept oscillators etc.
Cathode Ray Tube.....	1324C, 5" flat-faced screen, green medium-persistence phosphor.
Power Supplies.....	High-voltage supply; transformer-rectifier type, developing 1200 volts at output of RC filter system. Low-voltage supply; transformer-rectifier type, full electronic voltage regulation for all critical amplifier, time base generator and positioning potentials.

General:

Retrace Blanking.....	Blanking intervals less than 30% sweep rate regardless of sweep speed. Blanking amplifier provided.
Phasing Control.....	Provides fully controlled phase shift for 50 c/s sweep applications. Phasing continuously variable from zero to over 135 degrees.
Voltage Calibrator.....	Built-in source, 1 volt peak-to-peak; calibrated graticule and accurately calibrated input attenuator to permit voltage measurements over range of 10,000 to 1 or more.
Z-Axis Modulation.....	Provision for intensity modulation of electron beam through high-voltage isolation capacitor; 8 to 20 volts (RMS) required for complete blanking of trace.
Access Panel.....	Removable panel at rear of cabinet for access to CRT socket terminals. No terminals are provided for direct connection, since stray capacities introduced would be detrimental. When required, such connections can be readily made direct to socket terminals, without removing chassis from cabinet.
Power Requirements.....	200-250 volts 40-60 cycles AC at 80 watts; fused.
Dimensions.....	8.5/8" wide x 13 1/2" high x 18 1/2" deep.
Net Weight.....	22 lbs. (approx.)
Shipping Weight.....	25 lbs. (approx.)

be no.
and/or material

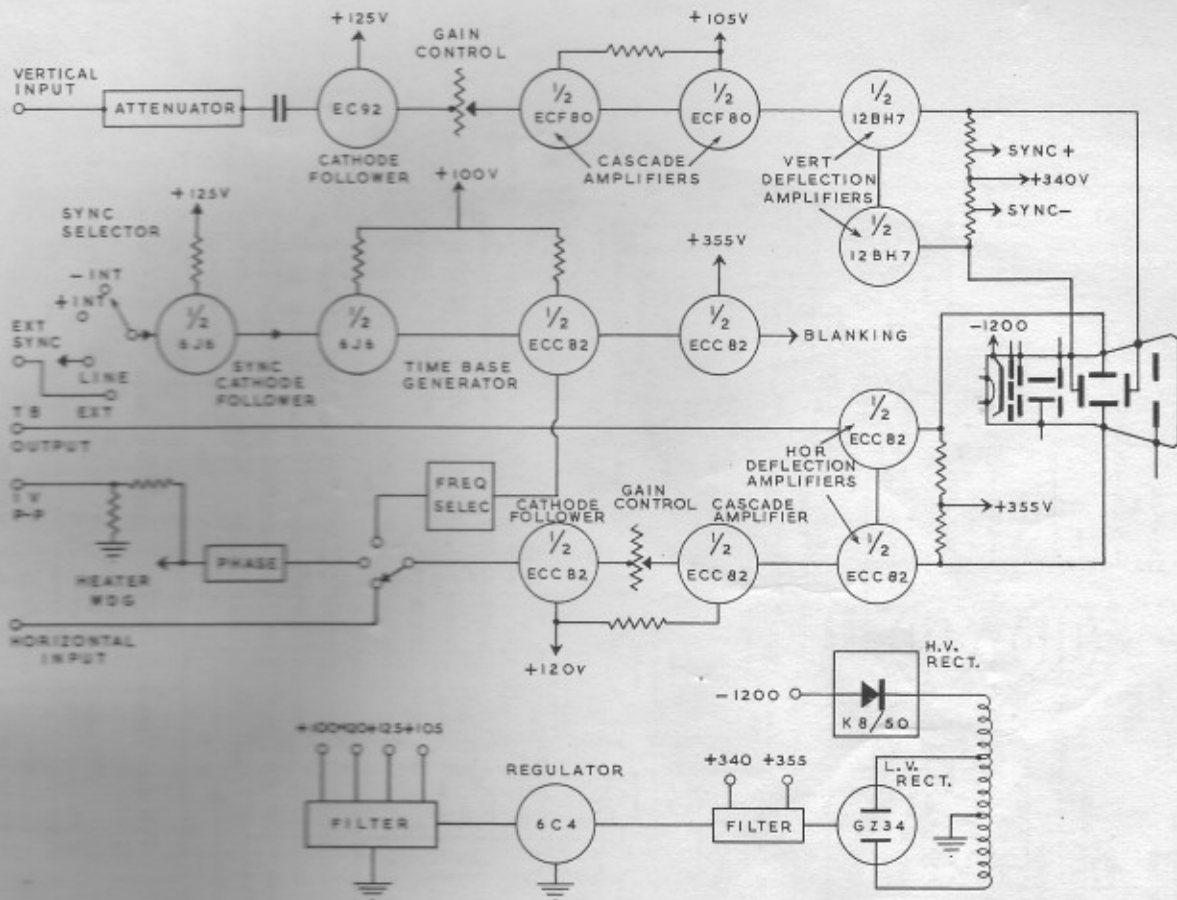

BLOCK DIAGRAM

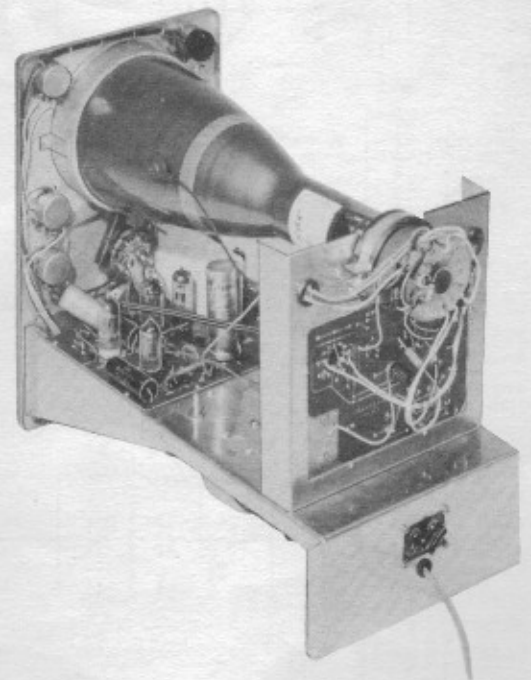
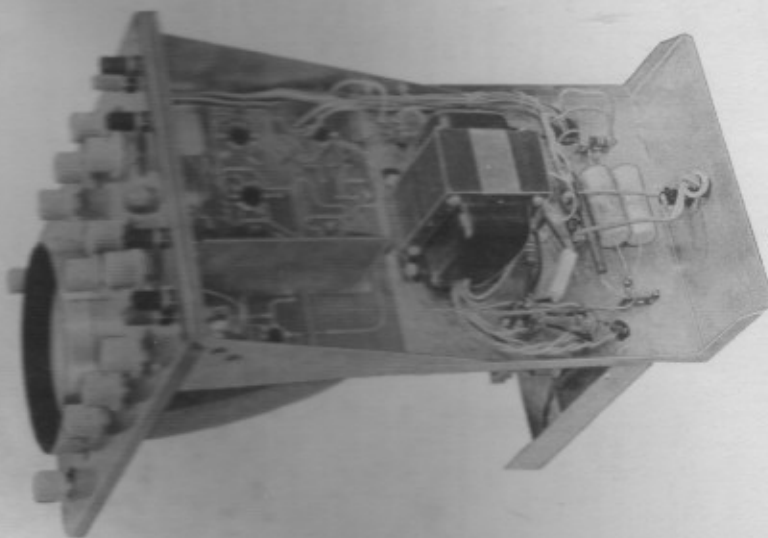

1. All switches shown in full CCW position.
2. All resistors marked in ohms and are $\frac{1}{2}$ watt unless specified.
3. All capacitors marked in μ F and are paper dielectric unless specified.
4. Multipliers: K x 1000, MEG x 1,000,000.

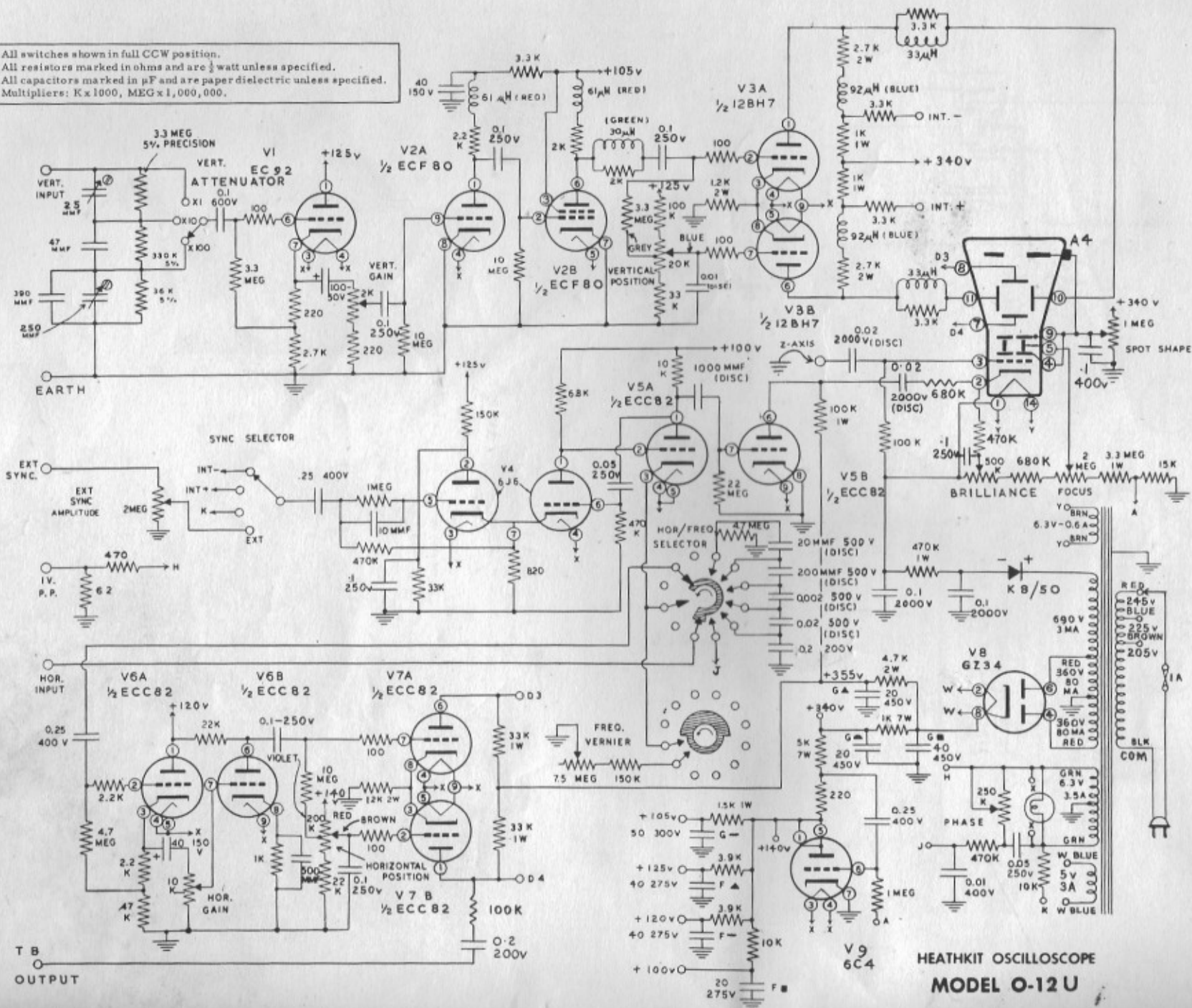

HEATHKIT OSCILLOSCOPE
MODEL O-12 U

PRELIMINARY NOTES AND INSTRUCTIONS

The Step-by-Step instructions given in this manual should be followed implicitly to ensure a minimum of difficulty during construction and a completely satisfactory result, including many years of accurate, trouble-free service from the finished instrument.

UNPACK THE KIT CAREFULLY, EXAMINE EACH PART AND CHECK IT AGAINST THE PARTS LIST. In so doing, you will become acquainted with the parts. If a shortage is found, attach the inspection slip to your claim and notify us promptly. Screws, nuts and washers are counted mechanically and if a few are missing, please obtain them locally if at all possible.

Lay out all the parts so that they are readily available in convenient categories. Refer to the general information inside the covers of this manual for instructions on how to identify components.

Moulded egg containers make handy trays for holding small parts. Resistors and capacitors may be placed in the edge of a corrugated cardboard box until they are needed.

Use lockwashers under all screws and nuts, and also between controls and the chassis. When shakeproof solder tags are mounted under nuts, the use of lockwashers is unnecessary.

Resistors and capacitors have a tolerance rating of $\pm 10\%$ unless otherwise stated. Therefore a 100 K Ω resistor may test anywhere between 90 and 110 K Ω . Frequently capacitors show an even greater variation such as -50% to $+100\%$. This Heathkit accommodates such variations.

Unless otherwise stated all wire used is insulated. Bare wire is only used where lead lengths are short and there is no possibility of a short circuit. Wherever there is a possibility of the bare wire leads of resistors or capacitors, etc., shorting to other parts or to chassis, such leads must be covered with insulated sleeving.

To facilitate describing the location of parts, all valveholders, controls, tag strips, etc., have been lettered or numbered. Where necessary all such coding is clearly shown in the illustrations. When instructions say, for example, "wire to socket G3", refer to the proper figure and connect a wire to tag 3 of socket G.

Valveholders illustrated in the manual are always shown with their tags numbered in a clockwise sequence, from the blank tag position or keyway, when viewed from underneath.

All rotary switch tags are numbered clockwise when viewed from the rear of the wafer, i.e. the end remote from the knob.

All resistors may be wired either way round.

All capacitors, excepting electrolytic capacitors, may be wired either way round unless otherwise stated.

Carefully letter and number tag strips, valveholders, transformers, etc. A wax pencil is ideal for this purpose.

When mounting resistors and capacitors make sure that the value can be read when in position.

Observe polarity on all electrolytic capacitors, i.e. RED = POSITIVE.

A circuit description is included in this manual so that those with some knowledge of electronics will be able to obtain a clearer picture of the actual functioning of this instrument. It is not expected that those with little experience will understand the description completely, but it should be of help in the event that they desire to become more familiar with the circuit operation and thus learn more from building the kit than just the placing of parts and the wiring.

Read this manual right through before starting actual construction. In this way, you will become familiar with the general step-by-step procedure used. Study the pictorials and diagrams to get acquainted with the circuit layout and location of parts. When actually assembling and wiring, READ THROUGH THE WHOLE OF EACH STEP so that no point will be missed.

A tick (✓) should be made in the space provided at the beginning of each instruction immediately it has been completed. This is most important as it will avoid omissions or errors, especially whenever work is interrupted in the course of construction. Some Kit-builders have found it helpful in addition to mark each lead in the pictorial in coloured pencil as it is completed.

Successful instrument construction requires close observance of the step-by-step procedure outlined in this manual. For your convenience, some illustrations may appear in large size folded sheets. It is suggested that these sheets be fastened to the wall over your work area for reference purposes during instrument construction.

The Company reserves the right to make such circuit modification and/or component substitutions as may be found desirable, indication being by "Advice of Change" included in the kit.

NOTE: Daystrom Ltd. will not accept any responsibility or liability for any damage or personal injury sustained during the building, testing, or operation of this instrument.

ALL GUARANTEES ARE VOIDED AND WE WILL NOT REPAIR OR SERVICE INSTRUMENTS IN WHICH ACID CORE SOLDER OR PASTE FLUXES HAVE BEEN USED. WHEN IN DOUBT ABOUT SOLDER, IT IS RECOMMENDED THAT ONLY "60/40" RESIN CORE RADIO SOLDER BE PURCHASED.

PROPER SOLDERING PROCEDURE

Only a small percentage of Heathkit purchasers find it necessary to return an instrument for factory service. Of these, by far the largest proportion function improperly due to poor or improper soldering.

Correct soldering technique is extremely important. Good soldered joints are essential if the performance engineered into the kit is to be fully realised. If you are a beginner with no experience in soldering, half an hour's practice with odd lengths of wire and a valveholder, etc., will be invaluable.

Highest quality resin-cored solder is essential for efficiently securing this kit's wiring and components. The resin core acts as a flux or cleaning agent during the soldering operation.

NO SEPARATE FLUX OR PASTE OF ANY KIND SHOULD BE USED. We specifically caution against the use of so-called "non-corrosive" pastes or liquids. Such compounds, although not corrosive at room temperature, will form residues when heated. These residues are deposited on surrounding surfaces and attract moisture. The resulting compounds are not only corrosive but actually destroy the insulation value of non-conductors. Dust and dirt will tend to accumulate on these "bridges" and eventually will cause erratic or degraded performance of the instrument.

IMPORTANT

IN THE "STEP-BY-STEP" PROCEDURE the abbreviation "NS" indicates that the connection should not yet be soldered, for other wires will be added. At a later stage the letter "S" indicates that the connection must now be soldered. Note that a number appears after each solder (S) instruction. This number indicates the number of leads connected to the terminal in question. For example, if the instructions read, "Connect one lead of a 47 K Ω resistor to tag 1 (S-2)", it will be understood that there should be two leads connected to the terminal at the time it is soldered. This additional check will help to avoid errors.

When two or more connections are made to the same solder tag a common mistake is to neglect to solder the connections on the bottom. Make sure all the wires are soldered.

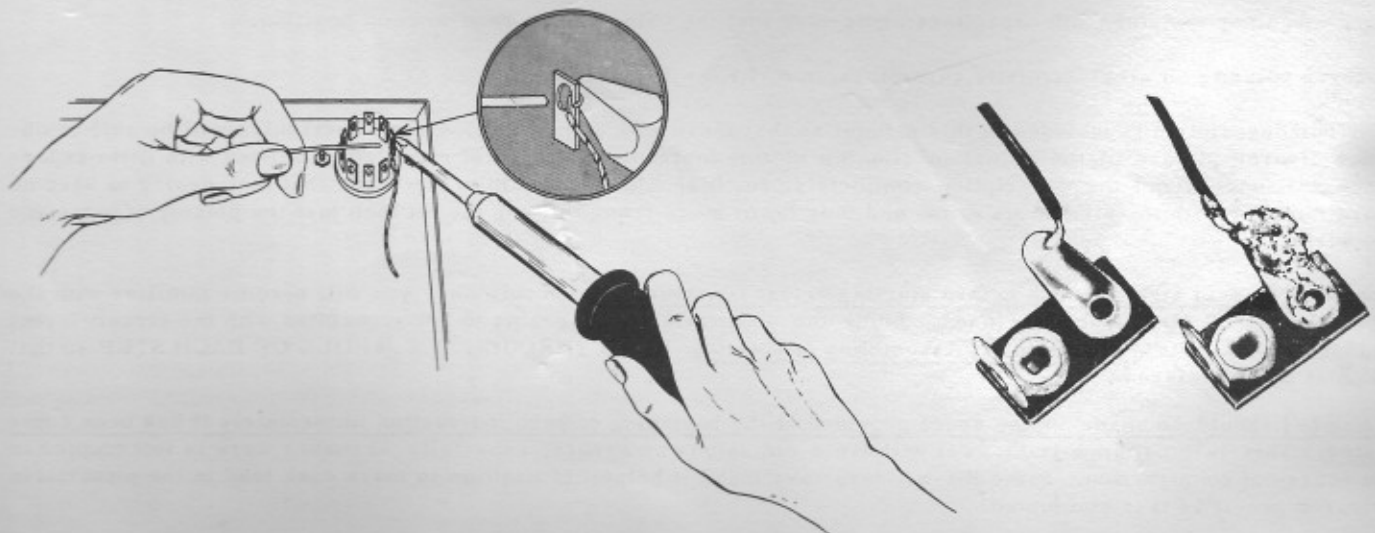

If the tags are bright and clean and wires free of wax, frayed insulation and other foreign substances, no difficulty will be experienced in soldering. Crimp or otherwise secure the wire (or wires) to the terminal, so a good mechanical joint is made without relying on solder for physical strength.

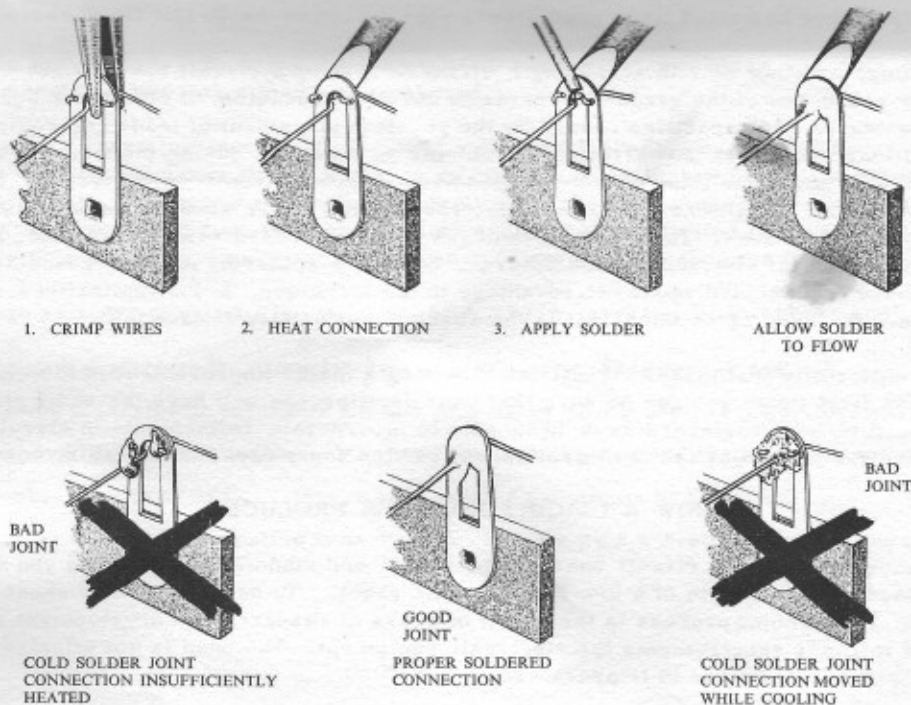

Typical good and bad soldered joints are shown above.

A poor soldered joint will usually be indicated by its appearance. The solder will stand up in a blob on top of the connection, with no evidence of flowing out caused by actual "wetting" of the contact. A crystalline or grainy texture on the solder surface caused by movement of the joint before it solidifies is another evidence of a "cold" connection and possible "dry" joint. In either event, reheat the joint until the solder flows smoothly over the entire junction, cooling to a smooth, bright appearance.

To make a good soldered joint, the clean tip of the hot soldering iron should be placed against the joint to be soldered so that the flat tag is heated sufficiently to melt the solder. Resin core solder is then placed against both the tag and the tip of the iron and should immediately flow over the joint. See illustrations. Use only enough solder to cover the wires at the junction; it is not necessary to fill the entire hole in the tag with solder. Don't allow excess solder to flow into valveholder contacts, ruining the sockets, or to creep into switch sockets and destroy their spring action. Position the work so that gravity tends to keep the solder where you want it.

A clean, well-tinned soldering iron is also important to obtain consistently perfect connections. For most wiring, a 25 to 50 watt iron, or the equivalent in a soldering gun, is very satisfactory. Keep the iron hot and its tip and the connections to be soldered bright and clean. Always place the solder on the heated "work" and then place the bit on top of the solder until it flows readily and "wets" the joint being made. Don't take the solder on to the bit and then try to bring it to the work directly from the soldering iron. Whenever possible a joint should be secured mechanically by squeezing tight with pliers prior to soldering it. The hot soldering bit should frequently be scraped clean with a knife, steel wool or a file, or wiped clean quickly by means of a rag or steel wool.

Don't apply too much solder to the soldered joint. Don't apply the solder to the iron only, expecting that it will roll down onto the connection. Try to follow the instructions and illustrations as closely as possible.

Don't bend a lead more than once around a connecting point before soldering, so that if it should have to come off due to a mistake or for maintenance it will be much easier to remove.

Follow these instructions and use reasonable care during assembly of the kit. This will ensure the deserved satisfaction of having the instrument operate perfectly the first time it is switched on.

NOTES ON CIRCUIT BOARD WIRING

In line with Daystrom's policy of continual improvement of its instruments, your Heathkit model O-12U Laboratory Oscilloscope utilises printed circuit boards. Incidentally, Heathkit models were the first kits to utilise this advanced technique and this experience has stood us in good stead in the design of the O-12U Oscilloscope.

The process of etching, printing or silk screening a wiring pattern on a circuit board is not an untried or experimental process. For years, one of the greatest hazards to quantity production of electronic equipment has been the variable "stray" inductances and capacities caused by the physical placement of leads and components. In critical circuits, these variations become an uncontrollable problem. In America, during the first great expansion of television in the late 1940's, a television tuner was developed using printed-circuit tuned circuits. It was so successful that the technique was applied to millions of military electronic items where absolute uniformity, reliability and low cost were paramount considerations. Today, the advantages of circuit board wiring have made it an almost mandatory system for any commercial electronic manufacturer. Since dip-soldering of many connections at one time reduces labour cost, there is a decided economic advantage to the technique. In kit applications, dip-soldering is not practicable of course. But even more important is the absolute uniformity of each unit.

It is this predictable uniformity that makes circuit-board wiring a major improvement in kit-constructed electronic instruments. For the first time, you can be sure that your oscilloscope will have the same characteristics as the development model. And, our engineers have been able to incorporate refinements in circuitry which otherwise would have been entirely swamped by the uncontrollable variables and strays introduced by conventional wiring.

HOW A CIRCUIT BOARD IS PRODUCED

It is important to understand how a circuit board is developed and manufactured so that you may fully realise its advantages. The board itself consists of a low-loss phenolic sheet. To one face of this sheet is bonded a layer of pure metallic copper. This bonding process is the result of years of research and development and has successfully passed the most rigid military requirements for electronic equipment. The bond is not affected by moisture, aging, etching solutions or normal variations in temperature.

The circuit pattern is developed after many experimental circuit layouts are tried and refined. The circuit is finally reduced to a drawing, bearing in mind necessary clearances for voltage breakdown, capacity effects, elimination of undesired feedback possibilities and a minimum of cross-overs. The final drawing, enlarged several times for greater accuracy, is photographed and a negative of exact size is produced. The copper surface of the circuit board is sensitised and exposed to light through the master negative. An etching process then removes all the copper except that protected by the opaque areas of the negative. The result is a copper "print" of the circuit pattern, as originally drawn.

Necessary holes are punched through the circuit board and circuit components are then mounted. For physical support, these parts are generally mounted on the phenolic side of the board with their leads passed through holes and soldered directly to the pattern. Soldering is simple and quick, using conventional methods.

One word of caution; we recommend that a small iron be used for circuit board soldering. The amount of heat required is much less than used for conventional wiring. Soldering pencils are ideal; a 25 or 50 watt iron is entirely adequate. Soldering guns should be used carefully, since they produce heat in direct ratio to length of time the switch is closed. Overheating can damage the circuit board and should be avoided. It is not necessary to "sweat" the connections. Any of the radio grades of solder work very well. **DO NOT USE SOLDER PASTES OR OTHER EXTERNAL FLUXES**, as they will completely ruin the circuit board.

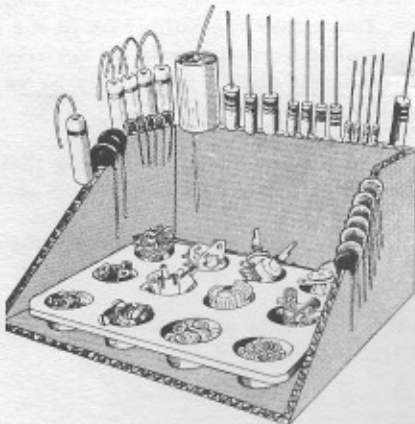

This illustration shows how resistors and capacitors may be placed in the cut edge of a corrugated cardboard carton until they are needed. Their values can be written on the cardboard next to each component.

STEP-BY-STEP ASSEMBLY INSTRUCTIONS

Read the note on assembly on the inside rear cover of the manual before you start work.

BE SURE TO READ EACH STEP ALL THE WAY THROUGH BEFORE YOU START TO DO IT.

CHASSIS SUB-ASSEMBLY (Reference Figure 2)

- () Mount the 8-pin valveholder V8, using 2 - 4BA x 3/8" screws, lockwashers and nuts orienting it as shown. (Figure 3 shows in detail how valve pins are numbered.)
- () Install the capacitor mounting plate at G, using 2 - 6BA x 5/16" screws, lockwashers and nuts. Install the 40-20-20-50 μ F electrolytic capacitor. Observe carefully the insulator of the terminal end of the capacitor and notice that each tag is identified by a coloured paint spot. Be sure these tags are oriented as shown in Figure 2. Slip the four mounting lugs through the slots and hold the capacitor can firmly against the plate. Now twist each of the four mounting lugs about 1/8 of a turn to secure the capacitor to the plate.
- () Mount the voltage selector panel at FH, using 4 - 6BA x 5/16" screws, lockwashers and nuts.
- () Mount a 3-tag terminal strip at H, using 1 - 4BA x 3/8" screw, lockwasher and nut.
- () Mount the 2 - 7-way tagstrips at locations EH and AC, using 4BA x 3/8" screws, lockwashers and nuts.
- () Take the 1 megohm SPOT SHAPE control QQ, bend the locating peg and install as shown in Figure 4.
- () Insert a 5/8" rubber grommet at GC. Insert 3/8" rubber grommets at GF and GL.
- () Mount the power transformer, orienting it as shown. Use 4 - 2BA x 3/8" screws, lockwashers and nuts.

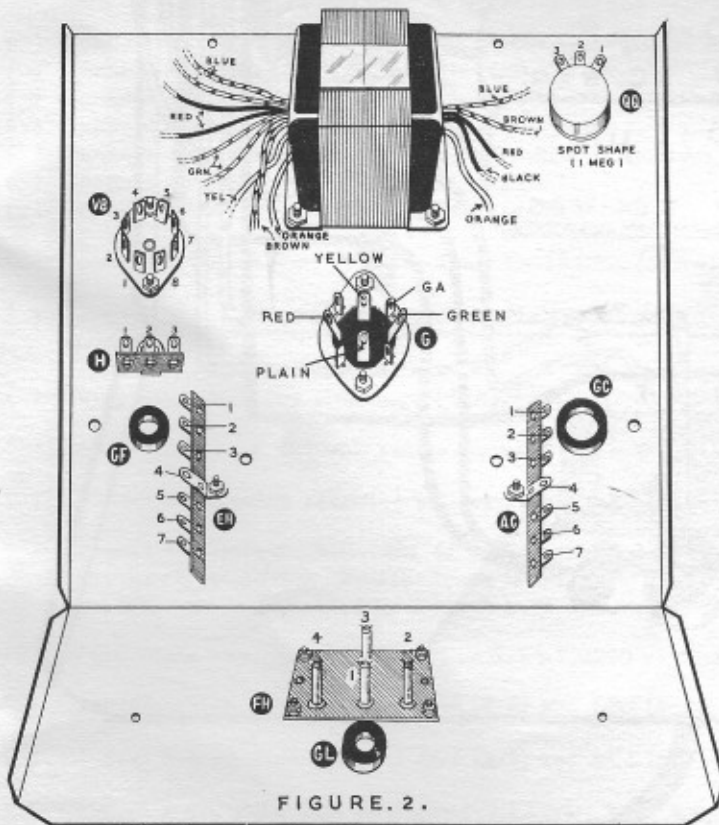
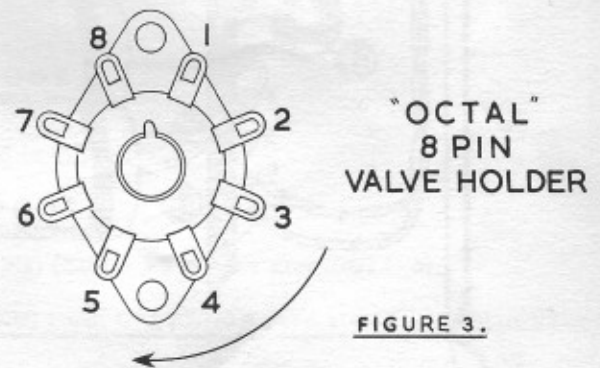
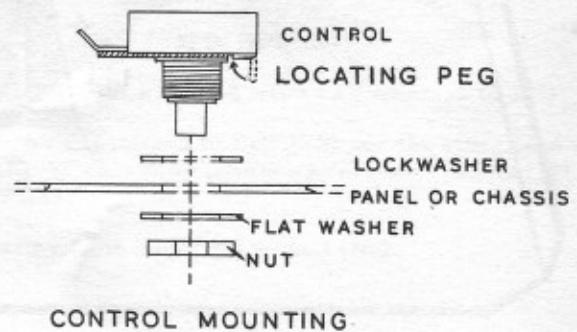

FIGURE 2.



"OCTAL"
8 PIN
VALVE HOLDER

FIGURE 3.



CONTROL MOUNTING

FIGURE 4.

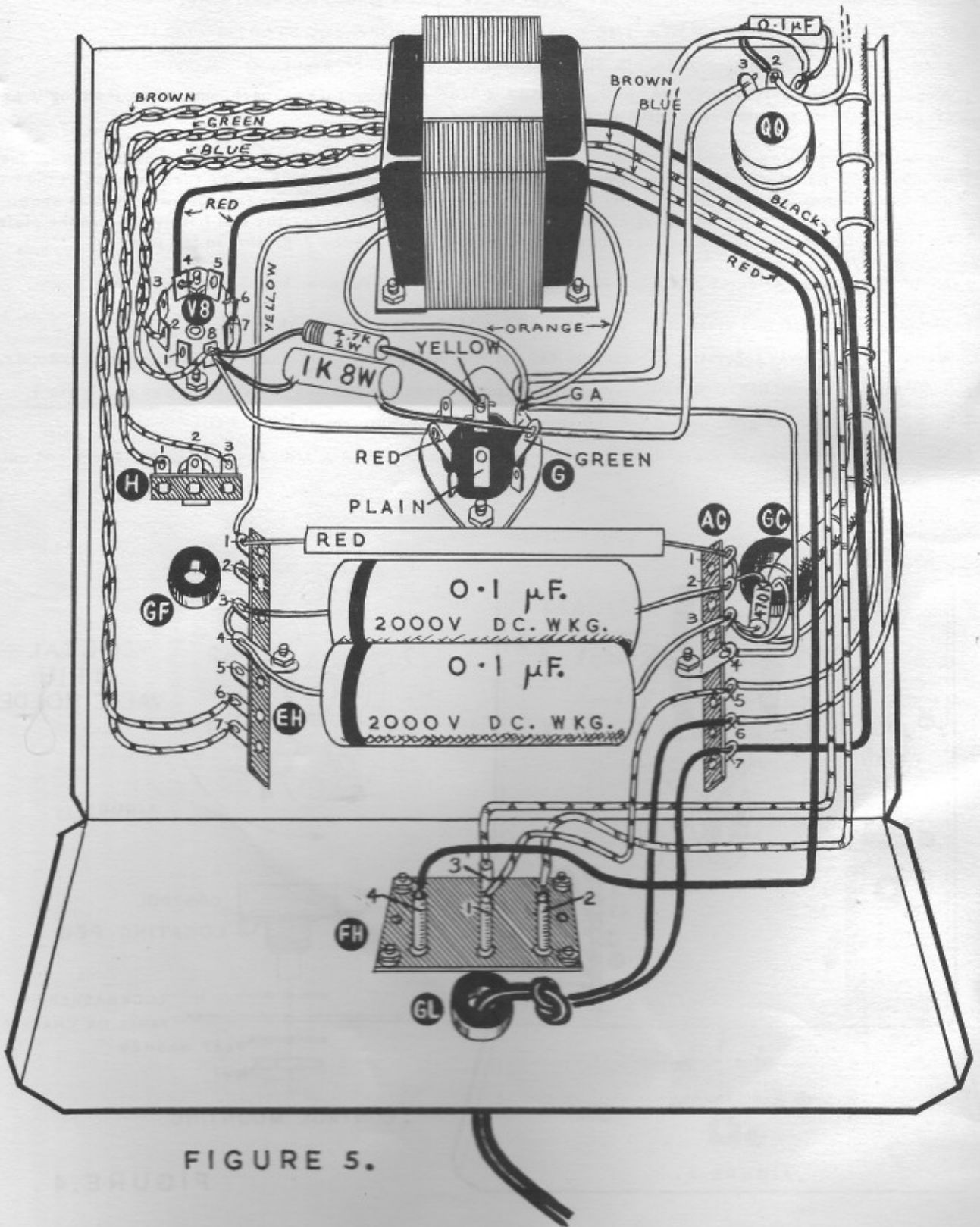

FIGURE 5.

CHASSIS WIRING

We again suggest that you place the large pictorial fold-in diagrams on the wall above your workspace so that they may be referred to readily.

Read the notes on the inside rear cover of this manual regarding wiring and soldering. Unless otherwise indicated, all wire used is insulated connecting wire. Wherever a possibility exists of a wire shorting to other parts, the lead should be protected by a length of insulated sleeving. This is indicated by the phrase, "use sleeving", in the instructions.

The leads on components are generally longer than necessary. These leads should be cut to the proper length, thus resulting in a neater looking instrument. In many instances, excessive lead lengths will actually affect the operation of the instrument and should be avoided.

POWER TRANSFORMER WIRING (Reference Figure 5)

- () Tin the slotted ends of the 4 pins of the voltage selector panel FH.
- () Twist together the RED, BLUE, BROWN and BLACK leads from the power transformer. Cut them to proper length and connect the BLACK lead to AC7 (NS). NOTE: For clarity these leads have been shown as straight leads.
- () Connect the BLUE lead to FH3 (S-1).
- () Connect the BROWN lead to FH2 (S-1).
- () Connect the RED lead to FH4 (S-1).
- () Connect a wire from FH1 (S-1) to AC5 (NS).
- () Twist together the two BROWN leads, connect either one to EH6 (NS) and the other to EH7 (NS).
- () Twist together the two GREEN leads, connect either one to H1 (NS) and the other one to H3 (NS). The varnish insulation must be removed by scraping the exposed wire end.
- () Twist together the two BLUE leads, connect either one to V8-2 (S-1) and the other one to V8-8 (NS). The varnish insulation must be removed by scraping the exposed wire end.
- () Connect the ORANGE leads to GA on the electrolytic capacitor (NS).
- () Connect the YELLOW lead to EH1 (NS).
- () Connect one RED lead to V8-4 (S-1).
- () Connect the other RED lead to V8-6 (S-1).
- () Connect a wire from QQ1 on the SPOT SHAPE control (NS) to GA (NS).
- () Connect a wire from GA (S-4) to AC4 (S-1).
- () Connect a lead from G-GREEN (NS) to QQ3 (NS).
- () Connect a 1 K Ω 8 watt resistor from G-GREEN (use sleeving) (NS) to V8-8 (use sleeving) (NS).
- () Connect a 4.7 K Ω 2 watt resistor (YELLOW, VIOLET, RED) from G-YELLOW (use sleeving) (NS) to V8-8 (use sleeving) (NS).
- () Using bare wire and sleeving, connect a lead from G-RED (S-1) to V8-8 (S-4).
- () Connect a 0.1 μ F 400 volt tubular capacitor from QQ2 (use sleeving) (NS) to QQ1 (S-2).
- () Connect the tubular rectifier between EH1 (S-2) and AC1 (NS). The RED end must be connected to EH1.
- () Connect the outside foil lead of one of the 0.1 μ F 2000 volt capacitors to EH3 (NS) and the other lead of this capacitor to AC2 (NS). Pull the leads taut to hold the body of the capacitor firmly against the chassis. The outside foil lead is indicated by a black band around the capacitor body.
- () In the same way, connect the other 0.1 μ F 2000 volt capacitor from EH4 (NS) to AC3 (NS).
- () Connect a bare wire between EH3 (S-2) and EH4 (S-2).
- () Connect a bare wire between AC1 (S-2) and AC2 (NS).
- () Connect a 470 K Ω 1 watt resistor (YELLOW, VIOLET, YELLOW) from AC2 (S-3) to AC3 (NS).
- () Take the mains lead and remove 2" of the outer braiding. To prevent fraying, bind with cotton or insulating tape.

- () Pass the stripped end of the mains lead through grommet GL, about 5" from the end, tie a knot for strain relief.
- () Connect the RED lead to AC6 (NS).
- () Connect the BLACK lead to AC7 (S-2).

PANEL SUB-ASSEMBLY

NOTE: Place a soft cloth pad under the panel to avoid damage.

- () Bend the locating peg on all controls as shown in Figure 4.
- () Mount the 500 K Ω BRILLIANCE control (insulated shaft) AA on the back of the panel, locating the terminals as indicated in Figure 8. Follow Figure 4 for assembly details.
- () Mount the 2 megohm FOCUS control (insulated shaft) BB.
- () Mount the 20 K Ω centre-tapped VERT. POS. control CC.
- () Mount the 200 K Ω centre-tapped HOR. POS. control DD.
- () Mount the 2 K Ω VERT. GAIN control EE. This control has a dummy tag for use as a tie point.
- () Mount the 10 K Ω HOR. GAIN control GG.
- () Mount the 4-terminal VERT. ATTENUATOR wafer switch at HH. Be sure the terminals are oriented as shown.
- () Mount the 7.5 megohm FREQ. VERNIER control KK.
- () Mount the 250 K Ω PHASE control at MM, locating the terminals as shown in Figure 8.
- () Mount the 2 megohm EXT. SYNC. AMPLITUDE control at LL.
- () Mount the 5-terminal SYNC. SELECTOR wafer switch at NN, being sure that the terminals are oriented as shown in Figure 8. This control has a dummy tag for use as a tie point.
- () Mount the pilot lamp socket PP, following Figure 6 for assembly details. Insert the 6v pilot lamp.
- () Following Figures 7 and 8, mount the VERT. INPUT terminal (RED) at RR, using the special low capacity insulators. These are the small round plastic bushes, note that four pins project from one face of the insulators, so spaced that two of the insulators can be meshed through the panel hole. Use a 4BA shakeproof solder tag and before tightening the nut, be sure that the cross-drilled wire hole is horizontal.
- () In the same way, mount BLACK terminals at VV (1 V P-P), SS (EXT. SYNC.) and a RED terminal at XX (HOR. INPUT). Be sure that the wire hole is horizontal on all three.

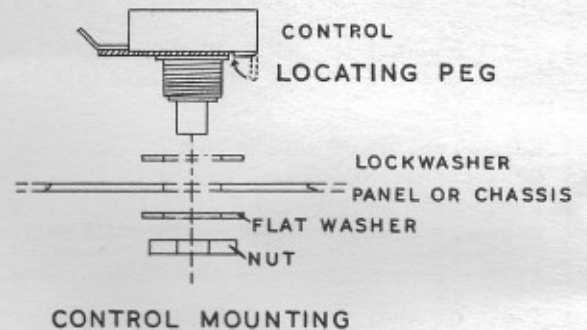

FIGURE 4.

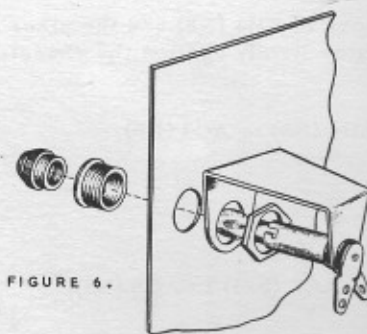

FIGURE 6.

PILOT LIGHT ASSEMBLY

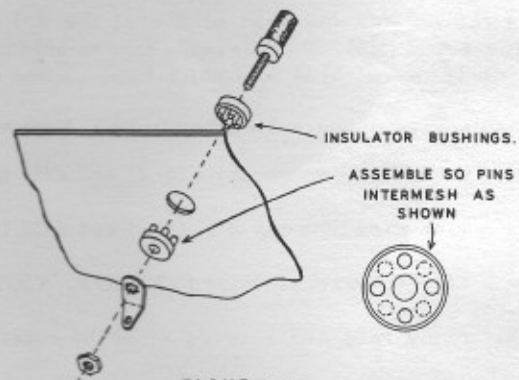

FIGURE 7.

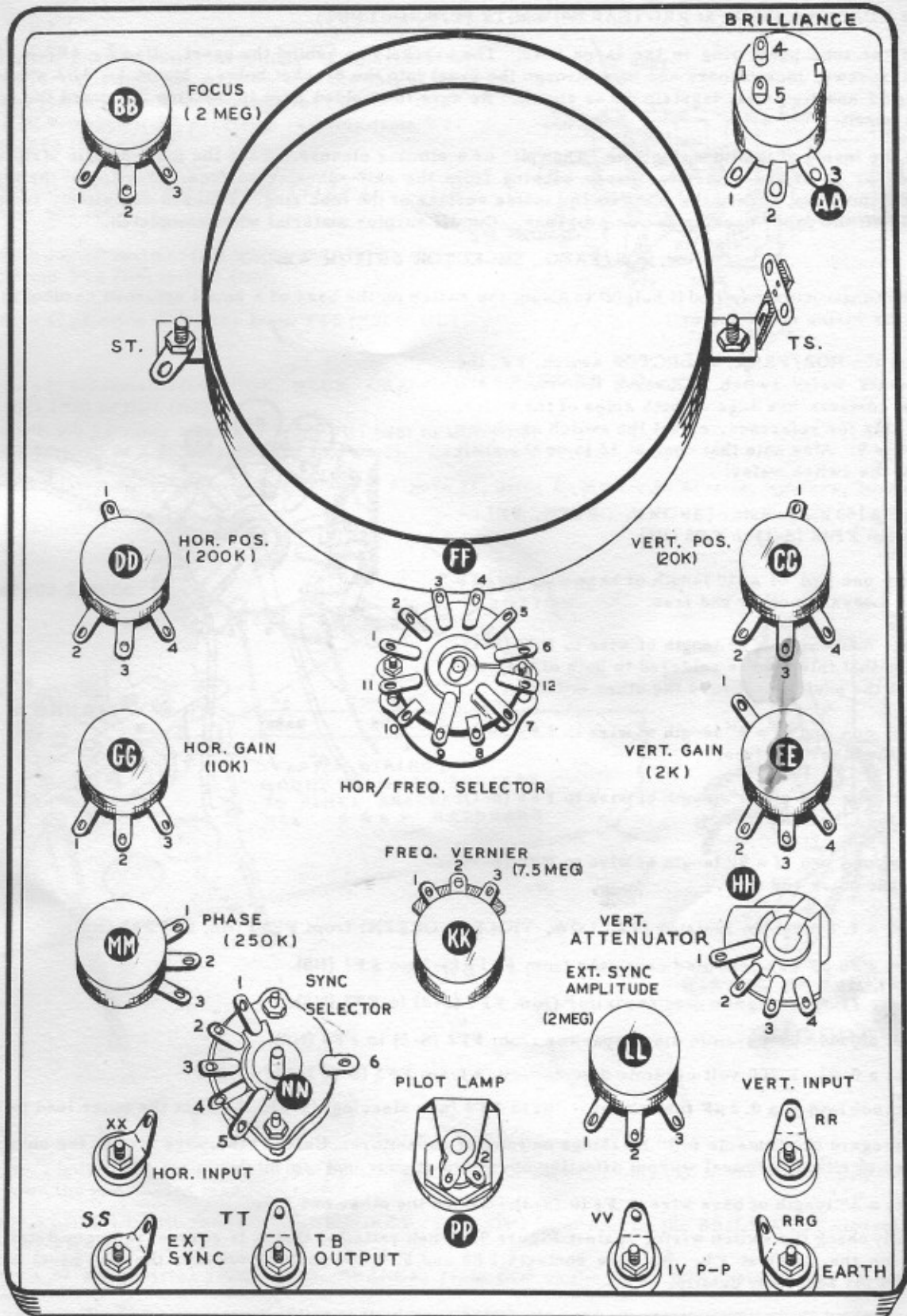

FIGURE 8.

- () Mount BLACK terminals at RRG (EARTH) and TT (T.B. OUTPUT).
- () Mount the tube panel ring in the large hole. The brackets go behind the panel. Use 2 - 4BA x 3/8" chrome plated screws, lockwashers and nuts through the panel into the bracket holes. Mount 1 - 4BA shakeproof solder tag ST and 1 - 1-way tagstrip TS as shown. Be sure the welded joint in the ring is toward the bottom edge of the panel.
- () Clean the inside of the tube ring with "Thawpit" or a similar cleaner. Take the foam plastic strip and peel off an inch or so of the protective paper backing from the self-adhesive surface. Starting at the top, i. e. "12 o'clock" position, insert the strip on the inside surface of the tube ring. Proceed completely round the ring, peeling off the paper backing as you progress. Cut off surplus material when completed.

HOR/FREQ. SELECTOR SWITCH WIRING

NOTE: The constructor may find it helpful to mount the switch on the base of a small upturned cardboard box. This will make the wiring much easier.

- () Identify the HOR/FREQ. SELECTOR switch, FF, the 12-contact wafer switch. Observe that one of the switch contacts has tags on both sides of the wafer. Using this for reference, orient the switch as shown in Figure 9. Also note that contact 12 is on the shaft side of the switch wafer.

- () Connect a 150 K Ω resistor (BROWN, GREEN, YELLOW) from FF12 (S-1) to FF8 (NS).

- () Connect one end of a 3" length of bare wire to FF8 (S-2). Leave the other end free.

- () Connect one end of a 4" length of wire to FF7 (S-1). Be sure that this lead is soldered to both of the contacts at the position. Leave the other end free.

- () Connect one end of a 4" length of wire to FF9 (S-1). Leave the other end free.

- () Connect one end of a 4" length of wire to FF5 (S-1). Leave the other end free.

- () Connect one end of a 9" length of wire to FF6 (S-1). Leave the other end free.

- () Connect a 4.7 megohm resistor (YELLOW, VIOLET, GREEN) from FF10 (NS) to FF11 (NS).

- () Connect a 20 pF ceramic disc capacitor from FF11 (S-2) to FF1 (NS).

- () Connect a 200 pF ceramic disc capacitor from FF1 (S-2) to FF2 (NS).

- () Connect a 0.002 μ F ceramic disc capacitor from FF2 (S-2) to FF3 (NS).

- () Connect a 0.02 μ F 500 volt ceramic disc capacitor from FF3 (S-2) to FF4 (NS).

- () Connect one lead of a 0.2 μ F tubular capacitor to FF4 (use sleeving) (S-2). Connect the other lead to FF10 (NS).

NOTE: Disregard the "outside foil" markings on tubular capacitors. Unless otherwise stated, the outside foil may be connected to either terminal without affecting operation of your instrument.

- () Connect a 3" length of bare wire to FF10 (S-3). Leave the other end free.

- () Carefully check the switch wiring against Figure 9. When satisfied that it is correct in every detail, mount the switch on the panel at FF. Be sure contacts FF3 and FF4 are pointing towards the tube panel ring. Follow Figure 4 for assembly details.

NOTE: Throughout these instructions, we have attempted to make it possible for you to re-check your work as each sub-assembly is completed and wired. If this procedure is followed, the chances of your making a serious error are greatly reduced. It is much easier to find and correct errors in the small sub-assemblies.

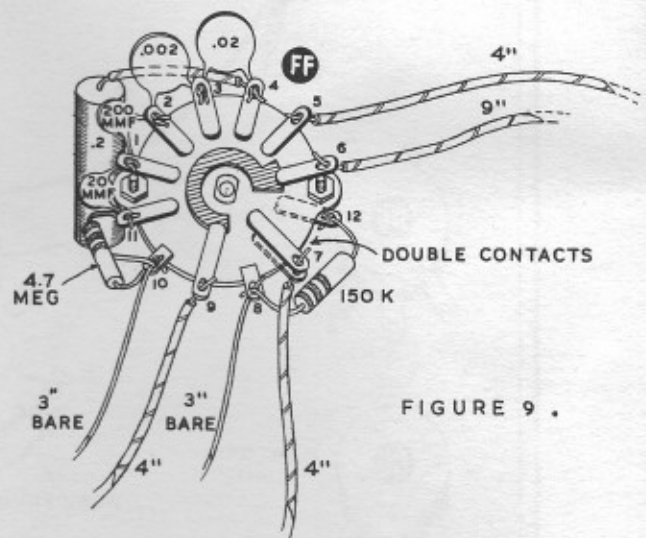

FIGURE 9 .

DUAL TRIMMER WIRING

- () Identify the dual trimmer assembly by reference to Figure 10. Position the part so that the roll of the trimmer plates is down, as shown in the Figure. Connect a 3.3 megohm 5% precision resistor from TT1 (NS) to TT2 (NS).
- () Connect one end of a 3" bare wire to TT1 (S-2). Leave the other end free.
- () Connect a 330 K Ω resistor (ORANGE, ORANGE, YELLOW) from TT2 (NS) to UU1 (NS).
- () Connect a 47 pF mica capacitor from TT2 (NS) to UU1 (NS).
- () Connect a 36 K Ω resistor (ORANGE, BLUE, ORANGE) from UU1 (NS) to UU2 (NS).
- () Connect a 390 pF mica capacitor from UU1 (NS) to UU2 (NS).
- () Connect one end of a 3" bare wire to UU2 (S-3). Leave the other end free.
- () Mount the dual trimmer assembly as shown in Figure 11, using 2 - 6BA x $\frac{3}{4}$ " screws, spacers, lockwashers and nuts.

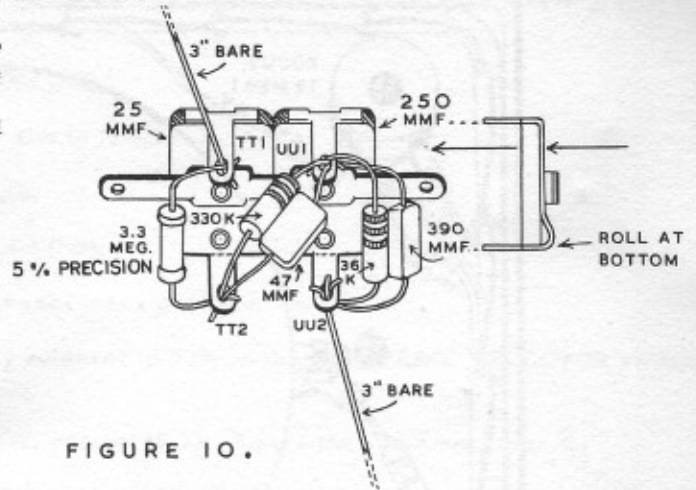

FIGURE 10.

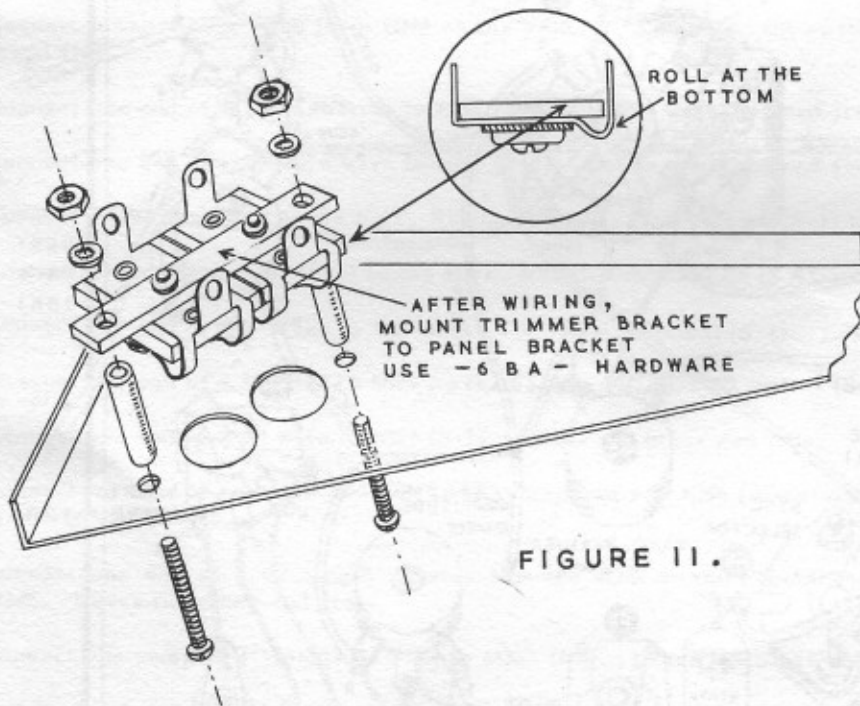
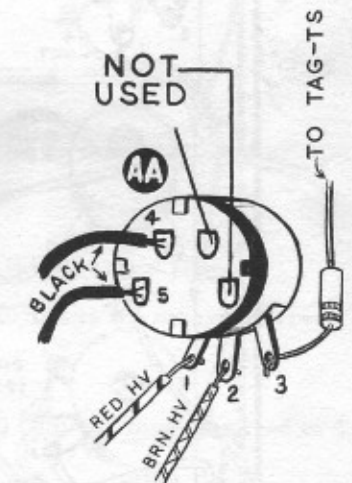

FIGURE 11.



WIRING OF BRILLIANCE CONTROL.

FIGURE 12

PANEL WIRING

- () Refer to Figure 12. Note that on the BRILLIANCE/ON-OFF switch only two of the four switch tags are used. Bend down the two unused tags.
- () Connect a 680 K Ω 1 watt resistor (BLUE, GREY, YELLOW) from AA3 on the BRILLIANCE control (S-1) to TS (NS). See Figure 13.
- () Connect a 22 K Ω resistor (RED, RED, ORANGE) from DD2 on the HOR. POS. control (use sleeving) (S-1) to ST (S-1).
- () Connect a 33 K Ω resistor (ORANGE, ORANGE, ORANGE) from CC4 on the VERT. POS. control (S-1) to EE1 on the VERT. GAIN control (NS).

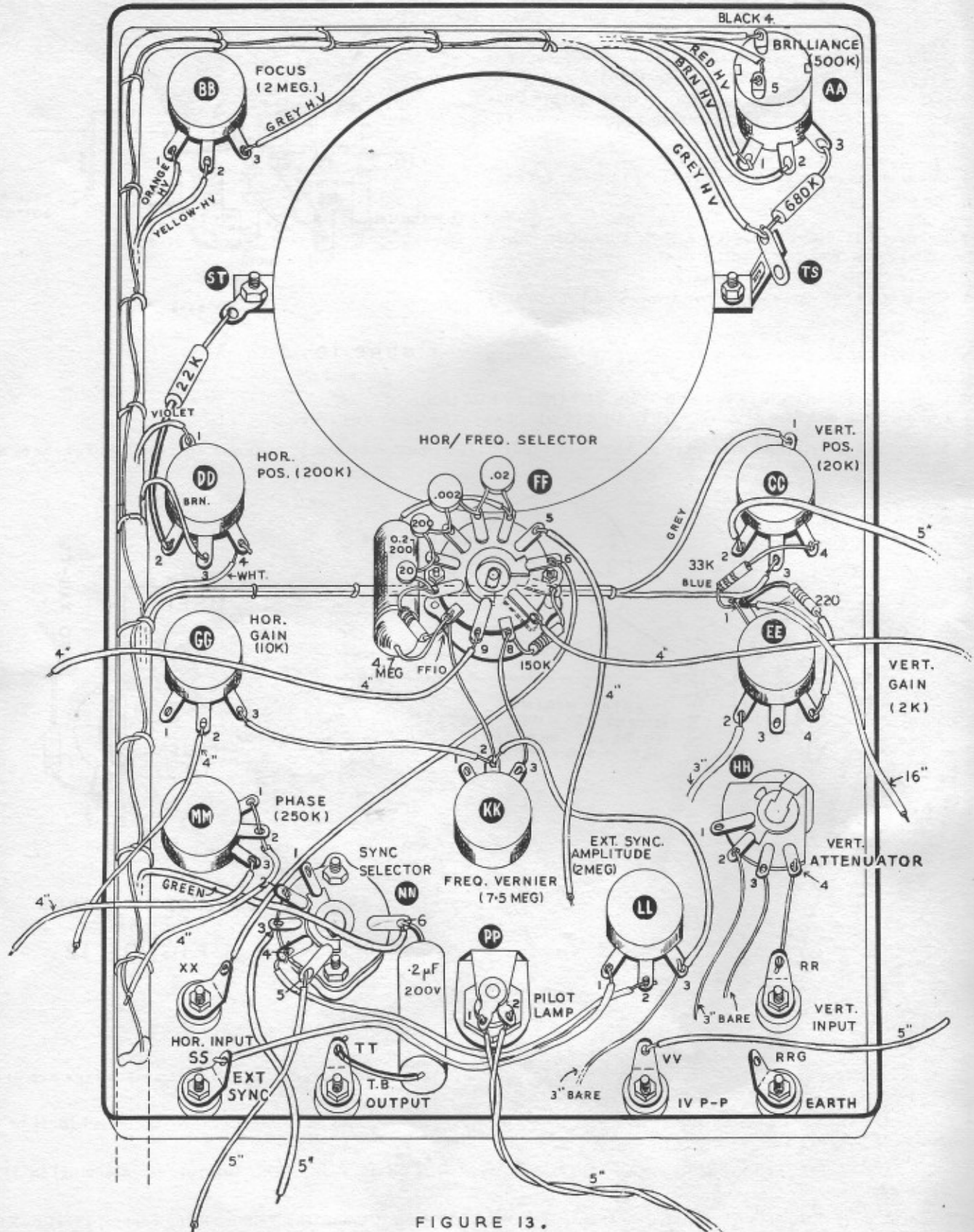

FIGURE 13.

MODEL O-12 U

- () Connect a 220 Ω resistor (RED, RED, BROWN) from EE1 on the VERTICAL GAIN control (use sleeving) (NS) to EE4 (use sleeving) (S-1).
- () Using bare wire and sleeving, connect GG3 (S-1) to KK2 (NS).
- () Connect the short bare wire from FF10 to KK2 (NS). Cut to length.
- () Connect the wire from FF8 to KK3 (S-1). Cut to length.
- () Using bare wire and sleeving, connect KK2 (S-3) to LL3 (NS).
- () Connect one end of a 3" bare wire to LL3 (S-2). Leave the other end free.
- () Connect the free end of the wire (other end previously soldered to FF6 on the HOR/FREQ. SELECTOR switch) to XX on the HOR. INPUT terminal (S-1).
- () Connect one end of a 5" wire to CC2 on the VERT. POS. control (S-1). Leave the other end free.
- () Connect one end of a 16" wire to EE1 on the VERT. GAIN control (S-3). Leave the other end free.
- () Connect one end of a 3" wire to EE2 (S-1). Leave the other end free.
- () Connect one end of a 4" wire to GG2 on the HOR. GAIN control (S-1). Leave the other end free.
- () Connect a short bare wire from HH4 on the VERT. ATTENUATOR switch (S-1) to RR, the VERT. INPUT terminal (NS).
- () Connect one end of a 3" bare wire to HH2 (S-1). Leave the other end free.
- () Connect one end of a 3" bare wire to HH3 (S-1). Leave the other end free.
- () Connect a wire from LL2 on the EXT. SYNC. AMPLITUDE control (S-1) to NN4 on the SYNC. SELECTOR (S-1).
- () Connect a wire from LL1 (S-1) to the EXT. SYNC. terminal SS (S-1).
- () Connect one end of a 5" wire to VV on the 1 V. P-P terminal (S-1). Leave the other end free.
- () Connect one end of a 5" wire to NN5 on the SYNC. SELECTOR switch (S-1). Leave the other end free.
- () Connect one end of a 5" wire to NN3 (S-1). Leave the other end free.
- () Connect one lead of a 0.2 μ F 200 volt tubular capacitor to NN6 (use sleeving) (NS) and the other lead to TT (use sleeving) (S-1).
- () Connect one end of a 4" length of wire through MM2 on the PHASE control (NS) to MM1 (S-1). Now solder MM2. Leave the other end free.
- () Connect one end of a 4" length of wire to MM3 (NS). Leave the other end free.
- () Twist together two 5" lengths of connecting wire. Strip all four ends. At one end of this pair, connect either lead to PP1 (S-1). Connect the other lead to PP2 (S-1). Leave the other end free.
- () Identify the panel end of the cable assembly or harness. This is the end with five leads, two BLACK conductors with thin insulation and three conductors with thick, or high-voltage insulation. These high-voltage conductors are colour coded BROWN, GREY and RED. The abbreviation HV, will refer to the conductors with heavy-wall insulation. Refer to Figure 13.
- () Place the panel end of the cable near the BRILLIANCE control AA. Connect the BROWN HV lead to AA2 (S-1).
- () Connect the RED HV lead to AA1 (S-1).
- () Connect either of the BLACK leads to AA4 (S-1) and the other to AA5 (S-1).

- () Connect the GREY HV lead to TS (S-2).
- () Route the cable along the top edge of the panel to the FOCUS control, then down along the "horizontal channel" side of the panel (the right edge viewed from the front).
- () Near the FOCUS control, connect the GREY HV lead to BB3 (S-1).
- () Connect the ORANGE HV lead to BB1 (S-1).
- () Connect the YELLOW HV lead to BB2 (S-1).

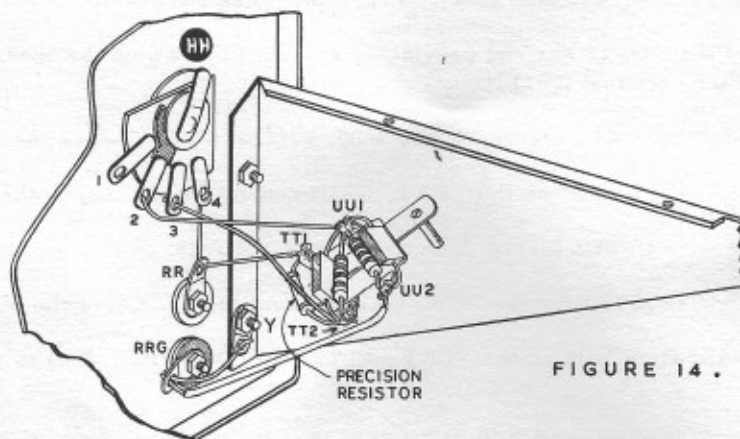

FIGURE 14.

- () Just below the HOR. POS. control, route the branch of the cable with the GREY and BLUE wires across the panel, between the tube ring and the HOR/FREQ. SELECTOR switch, to the VERT. POS. control.
- () Connect the GREY wire to CC1 (S-1).
- () Connect the BLUE wire to CC3 (S-1).
- () Connect the VIOLET wire to DD1 (S-1) and the BROWN wire to DD3 (S-1).
- () Connect the WHITE wire to DD4 (S-1).
- () Connect the GREEN wire to NN6 (S-2).

Refer now to Figure 14.

- () Attach the front panel to the chassis, using 4 - 4BA x 3/8" chrome plated screws, lockwashers and nuts as shown in Figure 20. Install a 4 BA shakeproof solder tag at location Y. Be sure the cable assembly is inside the bracket.
- () Connect the bare wire (other end previously soldered to TT1) to RR, the VERT. INPUT terminal (S-2). Cut to length.
- () Connect the bare wire (other end previously soldered to HH3) to TT2 (S-4).
- () Connect the bare wire (other end previously soldered to HH2) to UU1 (S-5).
- () Connect the bare wire (other end previously soldered to UU2) to RRG, the EARTH terminal (use sleeving) (NS).
- () Connect a short wire from RRG (S-2) to the solder tag Y (NS).
- () Connect the short bare wire (other end previously soldered to LL3, the EXT. SYNC. AMPLITUDE control) to Y (S-2).

CIRCUIT BOARD WIRING

Before attempting any work on the circuit boards, study Figure 15 and read the general instructions below carefully.

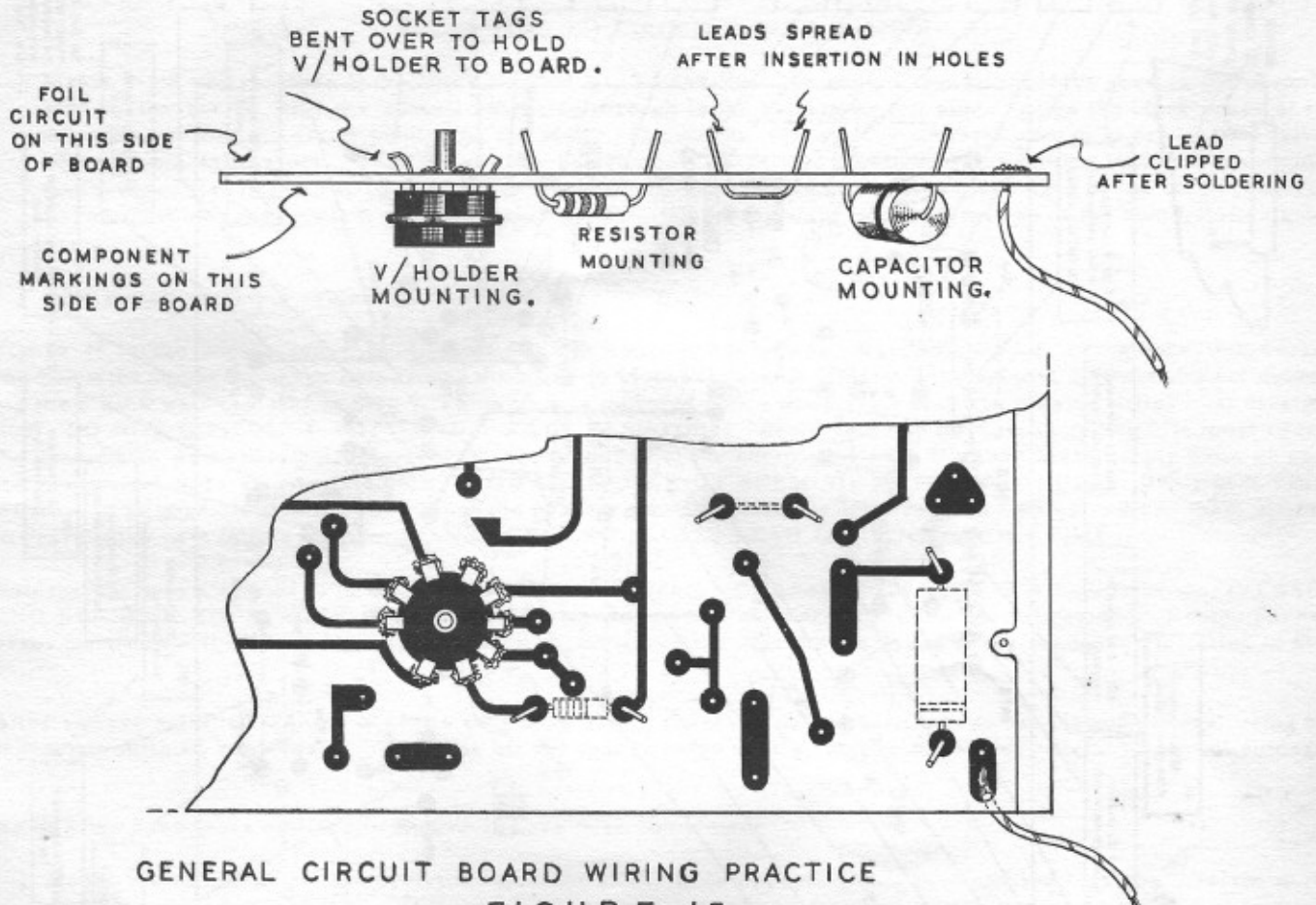

GENERAL CIRCUIT BOARD WIRING PRACTICE
FIGURE 15.

The following general rules are very simple and a few minutes spent in learning them will be an excellent investment. The growing application of circuit boards to all electronic equipment will soon require all technicians to be familiar with these practices.

1. NEVER USE SO-CALLED "NON-CORROSIVE" PASTES OR OTHER FLUXES. The copper foil on the circuit board has been specifically processed for ease in soldering. It will take solder perfectly, provided radio-grade resin-core solder is used. Very little solder is required to make a perfect connection. Try to prevent flow of flux onto the circuit board proper. Use only the thin gauge solder supplied with this kit.
2. DO NOT OVERHEAT THE CONNECTION. A 25 or 50 watt iron is entirely adequate for circuit board wiring. A soldering pencil is ideal. If a soldering gun is used, be very careful to avoid excessive heating. Try to develop a technique of "solder it and get off".
3. Remember that components are generally placed on the phenolic side of the board, with their leads passing through holes to the foil side of the board. Bend the leads slightly to prevent parts falling out as they are mounted, it is generally easier to mount most or all the parts in this way and then solder all the connections as one time.
4. The markings on the phenolic side of the board are there to assist you in wiring and to expedite your assembly. Follow the wiring sequence diagrams (Figures 16, 17, 18 and 19) so that no parts or jumpers are omitted.

SPECIAL NOTE: The tags of the valveholders supplied in this kit may be slightly longer than is necessary. The possibility exists that one of the tags may bridge across the circuit board and cause a short circuit. If too long, the tags should be shortened by clipping off a short length before installing the valveholder. In addition, the valveholders may be supplied with a circular tape disc as a tag retainer. This disc is to be removed after the valveholder has been soldered to the circuit board.

FRONT (LARGE) CIRCUIT BOARD WIRING

- () Insert 7-pin valveholders in the holes marked V1, V4 and V9. The body of the valveholder goes on the phenolic side of the board, with the contact extending through to the pattern or foil side. Align the blank space of the valveholder with the arrow printed on the side. Fan out the valveholder contacts enough to prevent the valveholder from falling out. Then rotate the valveholder slightly to obtain exact alignment between valveholder contacts and circuit pattern. **BE SURE** that no valveholder contact falls in the blank area of the circuit pattern. Carefully solder each contact to the adjacent pattern. Do not attempt to cut off the top of the contact after soldering.
- () Next install the 9-pin valveholders V5 and V6.

Figure 16 is the wiring sequence diagram for the front circuit board. Start with Step 1, in the upper left corner and follow the numbered operations around the board in clockwise order. Observe the special instructions for mounting the 5 K Ω 8 watt resistor in Step 9. This part is mounted above the circuit board to provide better heat dissipation. **DO NOT CONFUSE $\frac{1}{2}$ WATT AND 1 WATT RESISTORS.** Be sure to use the part called up. In most cases, the lead holes are spaced precisely to accept the leads of the component when they are bent sharply down as near the component body as possible. **IF THE PART DOES NOT SEEM TO MATCH THE HOLES, RECHECK YOUR WORK.** It is possible that the part is not the correct one. Slip both leads through the holes, spread them slightly to prevent the part falling out, but **DO NOT CUT OFF EXCESS LEAD LENGTHS AT THIS TIME.**

Note that there is a space () in each instruction box for checking. After all the parts have been mounted, **GO BACK AND RECHECK YOUR WORK COMPLETELY**, checking off each operation in the space provided. Remember, an error found now will save much difficulty later on. Observe the polarity markings of the condenser installed in Step 36.

After you are satisfied that the board is correctly wired, carefully solder each lead to the circuit pattern, using the technique outlined previously. Then cut off the excess leads neatly close to the solder fillet. Check all soldered joints.

AFTER the operations outlined in Figure 16 have been completed:

- () Mount the 40-40-20 μ F electrolytic capacitor at F. It is important that the coloured tags are inserted in the correct locations as shown. **DO NOT** attempt to mount this capacitor by twisting the mounting lugs in conventional fashion, but solder the mounting lugs to the circuit pattern surrounding the slots. Then solder the capacitor terminals in the same way. Do not attempt to cut off the tips of the lugs or terminals.

REAR (SMALL) CIRCUIT BOARD WIRING

- () Mount the three 9-pin valveholders and fan out the contacts. However, before soldering the valveholders to the circuit pattern, connect a short bare wire from pin 3 to pin 8 of valveholder V3 and V7. See Figure 18. Then solder the valveholders in place, being sure that the short jumper is well soldered to the contacts and to the circuit pattern.

Following Figure 19, proceed to complete the rear circuit board. Start at the top centre of the board and progress clockwise. When mounting the five peaking coils, hold the coil form tightly against the circuit board while spreading the terminals slightly. This will ensure that the coil form is perpendicular to the circuit board when the connections are soldered.

Follow the general procedure outlined for the front circuit board regarding assembly, soldering and lead clipping, and checking of soldered joints.

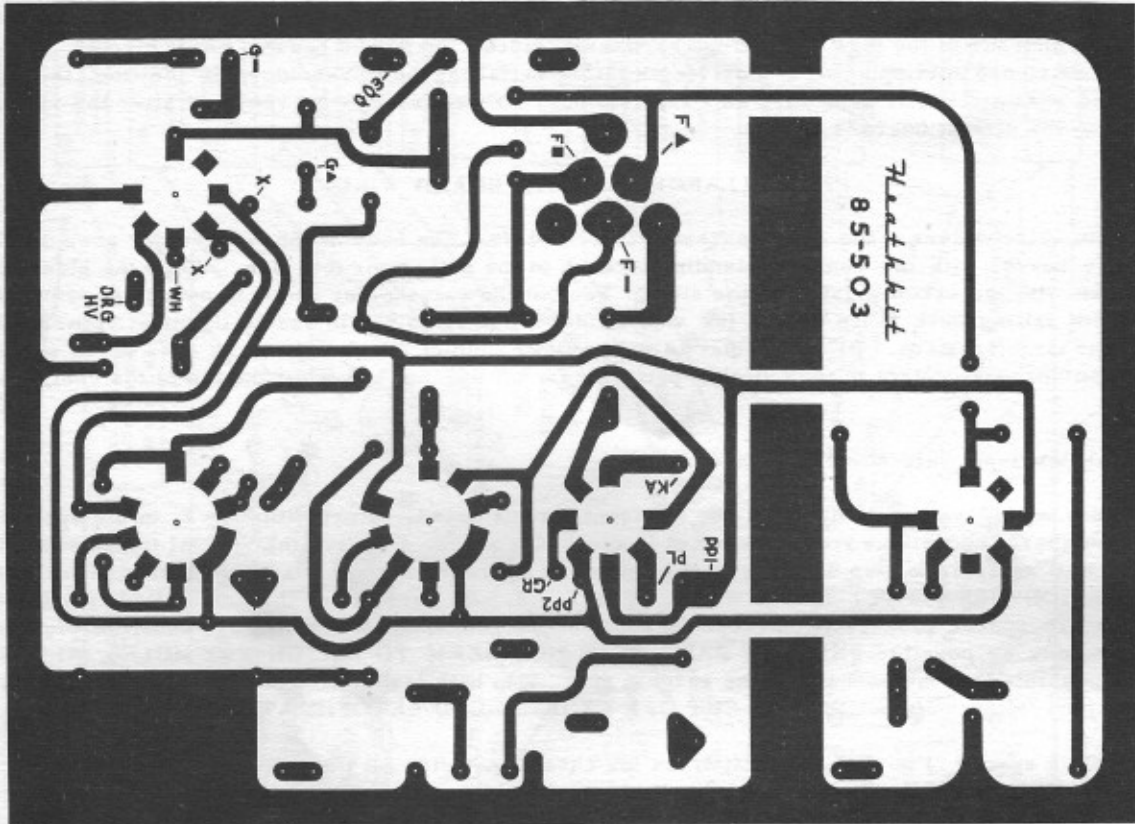

FIGURE 17

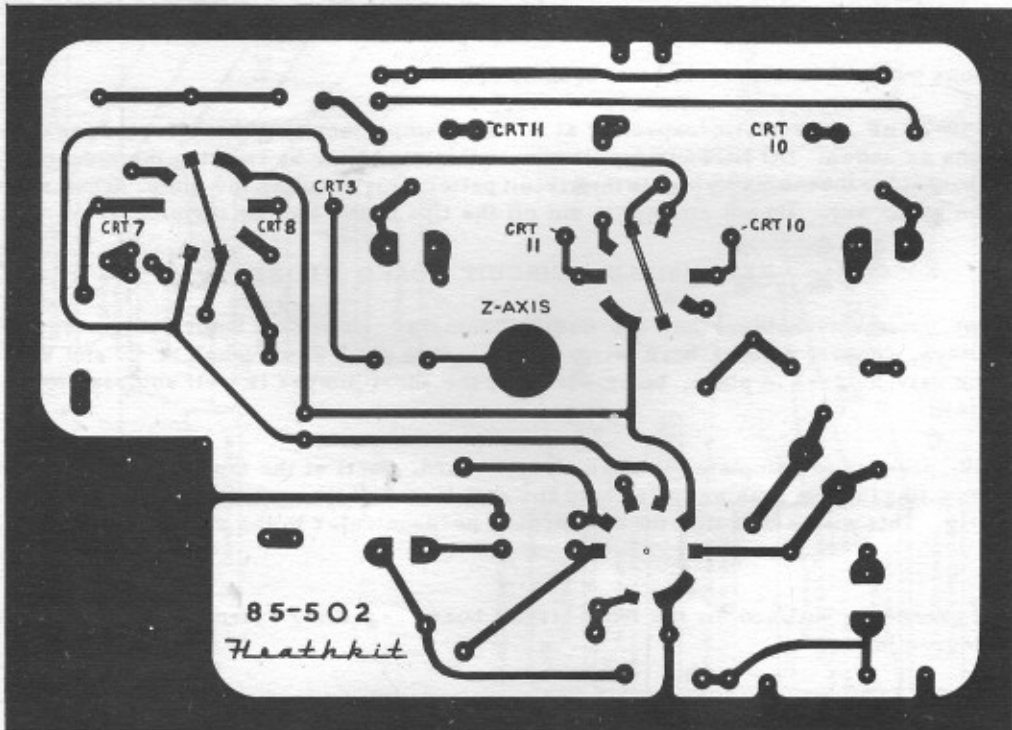

FIGURE 18.

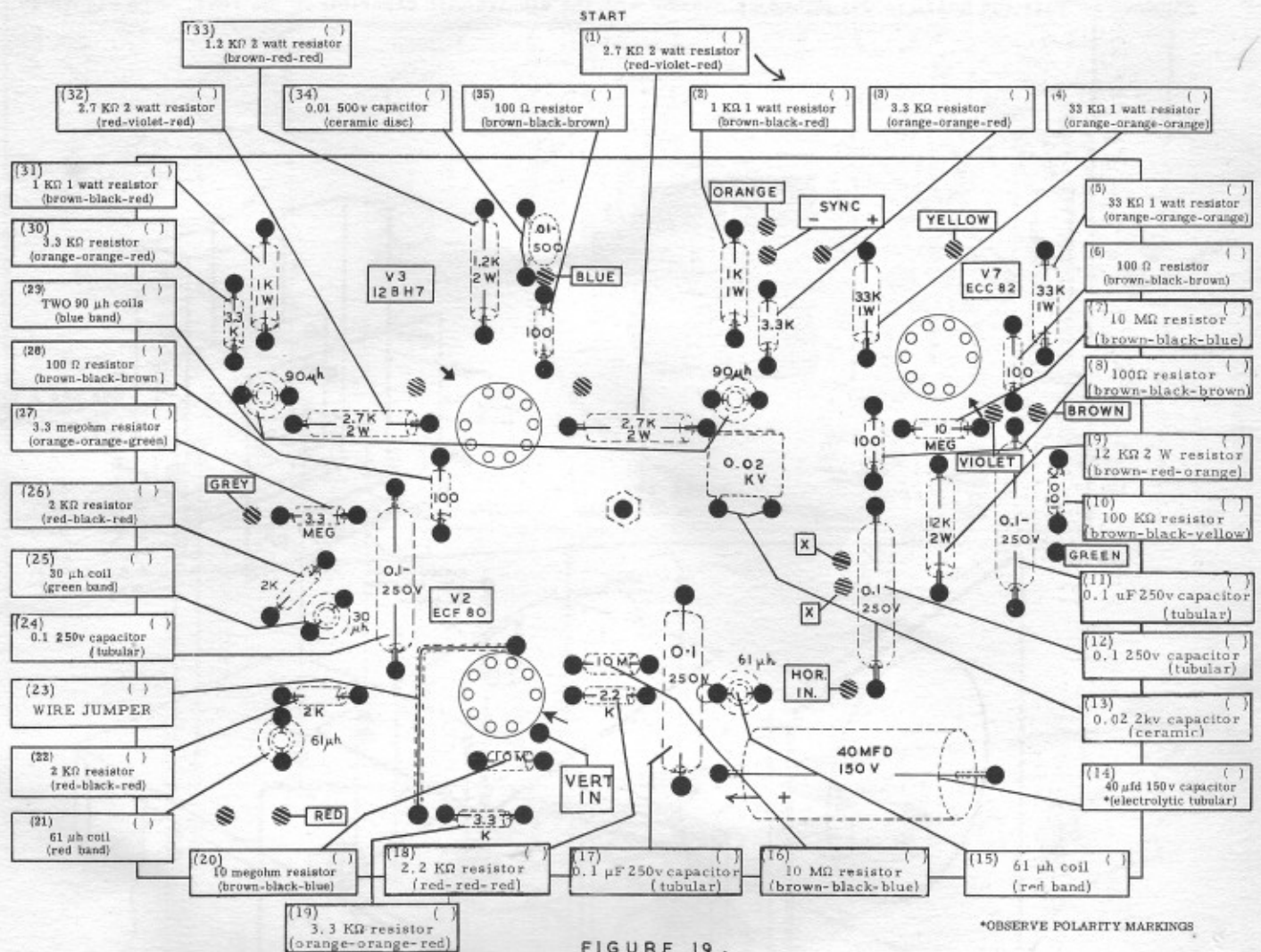
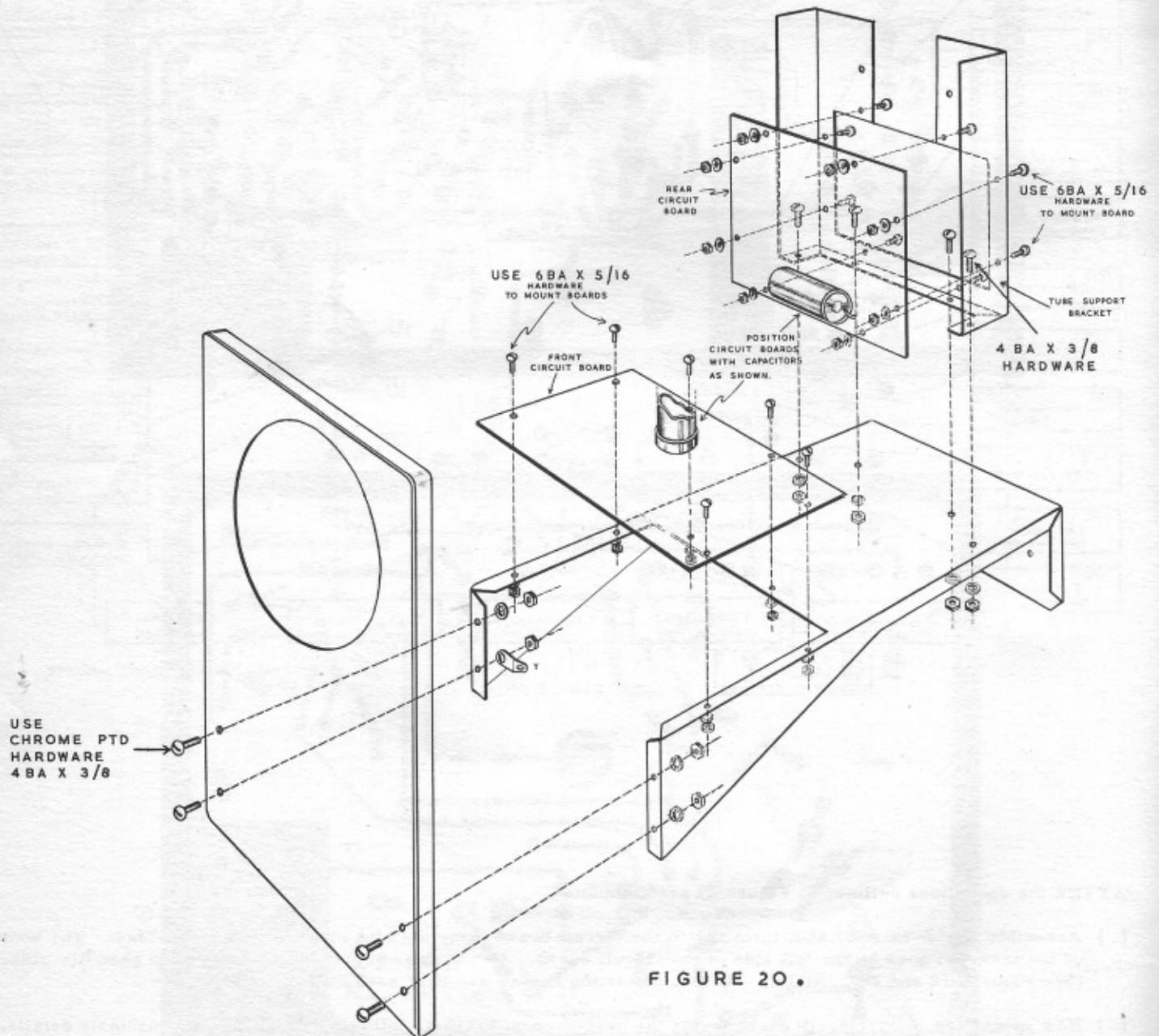

FIGURE 19.

AFTER the operations outlined in Figure 19 are completed:

- () Assemble the Z-axis BLACK terminal to the circuit board using the 4BA clearance hole provided. The body of the terminal goes on the foil side of the circuit board. Use a 4BA nut and lockwasher on the phenolic side. (See Figures 18 and 28.) NOTE: The two insulating bushes are NOT used in this instance.
- () Now mount the rear circuit board inside the tube-support bracket, following Figure 20 for assembly details. Use 8 - 6BA x 5/16" screws, lockwashers and nuts. The foil side of the board goes towards the rear of the instrument with the tubular electrolytic capacitor at the bottom.

- () Mount the tube-support bracket to the chassis, using 4 - 4BA x 3/8" screws, lockwashers and nuts. It will be helpful to insert the screw under the tubular electrolytic capacitor before the bracket is placed on the chassis. See Figure 20.
- () Mount the front circuit board to the chassis brackets, using 6 - 6BA x 5/16" screws, lockwashers and nuts as shown. Be sure the board is positioned as shown, with the electrolytic capacitor to the rear. See Figure 20.



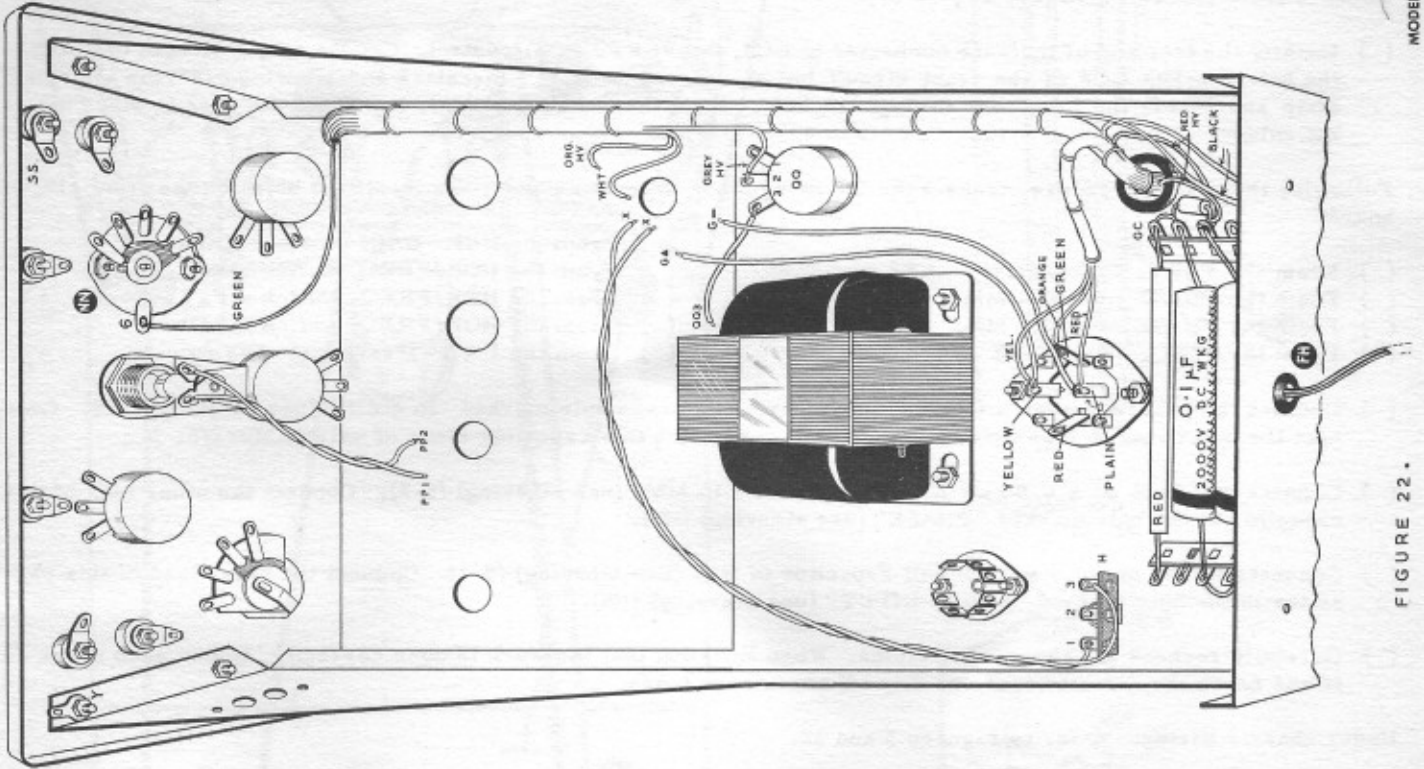

FIGURE 22.

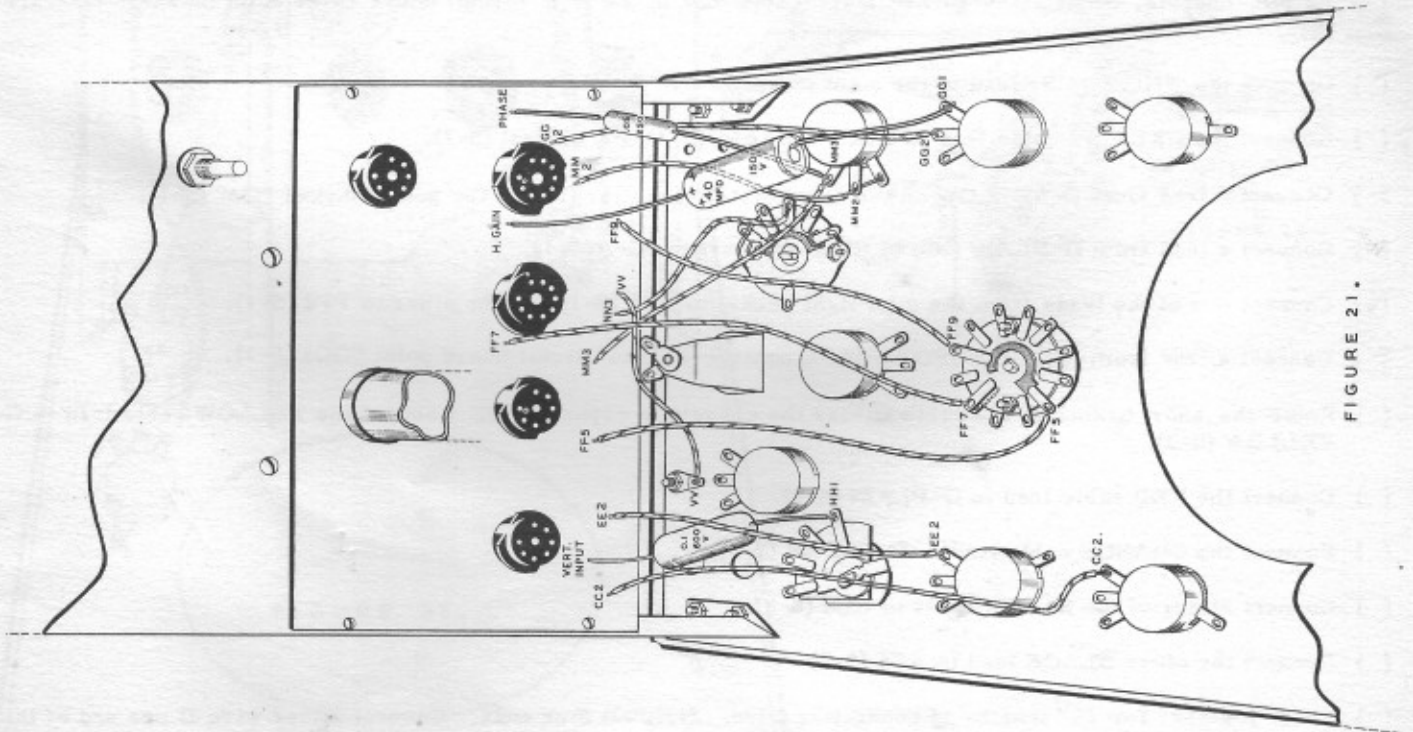

FIGURE 21.

FINAL WIRING

Panel to front circuit board (see Figure 21).

- () Identify the free end of the wire connected to CC2, the VERT. POS. control. Cut the wire to length to reach to the hole marked CC2 of the front circuit board, leaving about $\frac{1}{2}$ " for slack and allowing $\frac{3}{8}$ " for stripping. Strip and insert the bare wire through the hole. Bend the end over slightly to secure the wire in place but do not solder.

Following the above procedure, connect the following leads to their respectively identified holes on the front circuit board:

- | | |
|--|---------------------------------------|
| () From the VERT. GAIN control - EE2 | () From the HOR. GAIN control - GG2. |
| () From the PHASE control - MM3 | () From the HOR/FREQ. switch - FF5 |
| () From the PHASE control - MM2 | () From the HOR/FREQ. switch - FF7 |
| () From the SYNC. SELECTOR switch - NN3 | () From the HOR/FREQ. switch - FF9 |
| | () From the 1 V P-P terminal - VV |
- () Connect the positive end of a 40 μ F 150 volt capacitor to the hole marked "H. GAIN" (use sleeving) (NS). Connect the other lead to GG1 (use sleeving) (S-1). Position this capacitor clear of valveholder V6.
 - () Connect one lead of a 0.05 μ F 250 volt capacitor to MM3 (use sleeving) (S-2). Connect the other lead of this capacitor to the hole marked "PHASE" (use sleeving) (NS).
 - () Connect one lead of a 0.1 μ F 600 volt capacitor to HH1 (use sleeving) (S-1). Connect the other lead of this capacitor to the hole marked "VERT. INPUT" (use sleeving) (NS).
 - () Carefully recheck the above connections. When satisfied that the work is done correctly, solder each of the 13 points below the circuit board and clip off any excess leads.

Under chassis wiring. Refer to Figures 5 and 22.

- () Route the cable back along the "horizontal" chassis edge to grommet GC. Pass the longer branch of the cable up through grommet GC. Connect the two RED HV leads to AC3 (S-4).
- () At mid-chassis, connect the ORANGE HV cable lead to the front circuit board at the point marked "ORG HV" (S-1).
- () Connect the WHITE cable lead to the point marked "WH" (S-1).
- () Connect the GREY HV cable lead to QQ2 on the SPOT SHAPE control (S-2).
- () Connect a lead from G-YELLOW on the electrolytic capacitor (NS) to the point marked "G▲" (S-1).
- () Connect a lead from G-PLAIN (NS) to the point marked "G-" (S-1).
- () Connect one of the leads from the pilot light socket to PP1 (S-1) and the other to PP2 (S-1).
- () Connect a lead from QQ3, the SPOT SHAPE control (S-2) to circuit board point "QQ3" (S-1).
- () Route the short branch of the cable across the chassis to capacitor G. Connect the YELLOW cable lead to G-YELLOW (S-3).
- () Connect the RED cable lead to G-PLAIN (S-2).
- () Connect the ORANGE cable lead to G-GREEN (S-3).
- () Connect either of the BLACK leads to AC5 (S-2).
- () Connect the other BLACK lead to AC6 (S-2).
- () Twist together two 13" lengths of connecting wire. Strip all four ends. Connect either wire at one end of this twisted pair to H1 (NS) and the adjacent wire to H3 (NS). At the other end, connect a lead to each of the points marked X. Solder the two points.

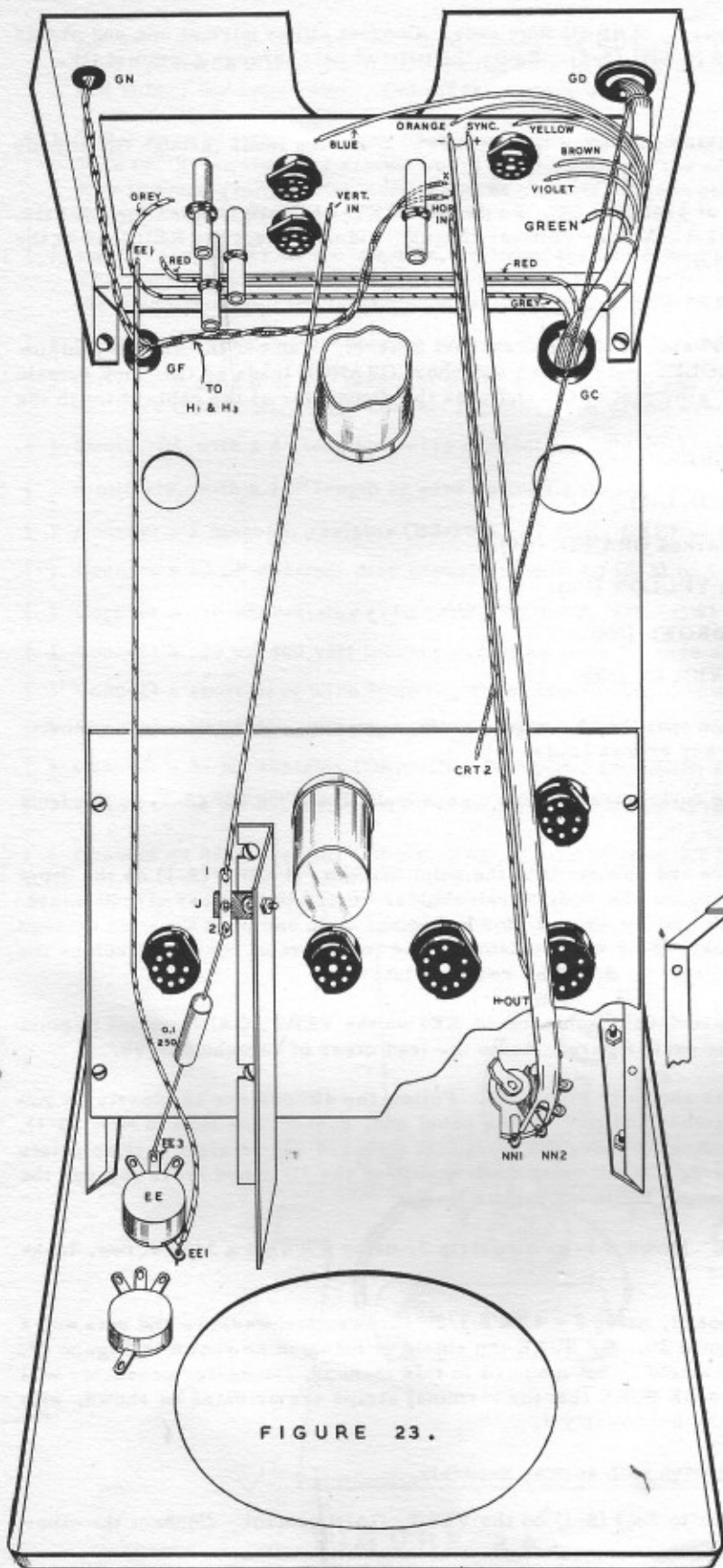
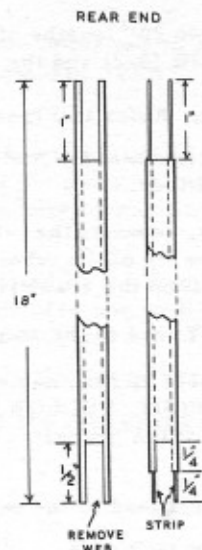

FIGURE 23.



PANEL END
FIGURE 24

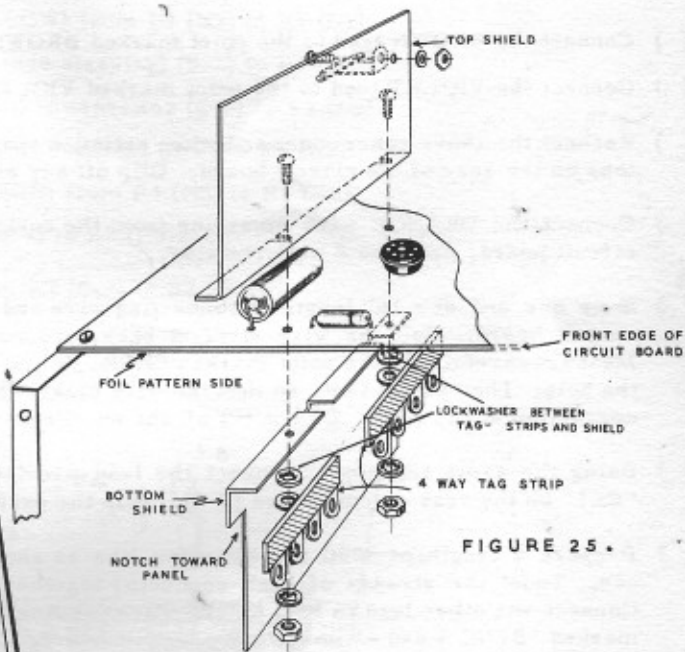

FIGURE 25.

- () Twist together two 20" lengths of connecting wire. Strip all four ends. Connect either wire at one end of this twisted pair to EH6 (S-2) and the adjacent wire to EH7 (S-2). Route the twisted pair through grommet GF.

Above chassis wiring. Refer to Figure 23.

- () Insert a 3/8" grommet at GN and route the twisted pair from GF as shown. Pass the leads through GN and for the present leave free.
- () Above the chassis, separate the cable branches at grommet GC. Route the GREY-RED pair across the chassis, forming it into the lip of the tube-support bracket. At the "vertical channel" side, connect the RED lead to the point marked RED on the rear circuit board (NS).
- () Connect the GREY lead to the point marked GREY (NS).
- () Pass the main cable up the "horizontal channel" side of the tube-support bracket. Fan out the branch containing the GREEN, BLUE, YELLOW, BROWN, VIOLET and the long and short ORANGE leads so that they remain on the front side of the bracket. Insert a 5/8" grommet at GD and pass the remainder of the cable through the grommet.
- () Connect the GREEN lead to the point marked GREEN (NS).
- () Connect the BLUE lead to the point marked BLUE (NS).
- () Connect the short ORANGE lead to the point marked ORANGE (NS).
- () Connect the YELLOW lead to the point marked YELLOW (NS).
- () Connect the BROWN lead to the point marked BROWN (NS).
- () Connect the VIOLET lead to the point marked VIOLET (NS).
- () Recheck the above connections and when satisfied that they have been made correctly, solder the eight connections on the rear of the circuit board. Clip off any excess leads.
- () Connect the ORANGE wire emerging from the cable assembly near grommet GD to "CRT2" (S-1) on the front circuit board, near the 8 watt resistor.
- () Strip one end of a 16" length of connecting wire and connect it to the point marked "H-OUT" (S-1) on the front circuit board. Pull the wire straight back, around the body of valveholder V6 and to the rear circuit board. Measure carefully to the point marked "HOR. IN", allow about 1" for stripping, strip and push the wire through the hole. Then pull it taut, so that the wire clears the 8 watt resistor on the front circuit board and solder the connection at the rear. Do not cut off the excess wire; it will be required later.
- () Using the same technique, connect the lead previously soldered to EE1 on the VERT. GAIN control to point "EE1" on the rear circuit board (S-1). Clip the excess wire. Route the lead clear of valveholder V8.
- () Prepare a length of 300Ω transmission line as shown in Figure 24. Follow the dimensions as closely as you can. Twist the strands of each conductor together and tin. At the panel end, connect one lead to NN2 (S-1). Connect the other lead to NN1 (S-1). Pass the line up above the front circuit board and straight back to points marked "SYNC + and -" on the rear circuit board. Do not twist the line. Pass the 1" tinned leads through the two holes, pull taut and solder the two connections. Trim off excess leads.
- () Identify the top shield, referring to Figure 25. Mount a 1-way tagstrip J, using 1 - 4BA x 3/8" screw, lockwasher and nut.
- () Mount the bottom shield to the front circuit board, using 2 - 4BA x 3/8" screws, lockwashers and nuts and a 4-way tagstrip on each screw, as shown in Figure 25. BE SURE the shield is mounted as shown in Figure 25, with the notched corner next to the panel. If the shield is not mounted in this manner, the heater conductor will be shorted and the circuit board destroyed. Also BE SURE that the terminal strips are oriented as shown, with the tags away from the shield. Do not tighten the hardware yet.
- () Slip the top shield under the screw heads and tighten both screws securely.
- () Connect one lead of a 0.1 μF 250 volt capacitor to EE3 (S-1) on the VERT. GAIN control. Connect the other lead to JZ (S-1). See Figure 23.

- () Connect one end of a 10" length of connecting wire to J1 (S-1). Strip the other end to expose about 1" of bare wire, push the stripped end through the hole in the rear circuit board, marked "VERT. IN", pull the wire taut and solder the connection. Cut off the excess wire.
- () Twist together two 10" lengths of connecting wire. Strip all four ends. At one end of the pair connect either wire to "X" on the rear circuit board (S-1). Connect the adjacent end to the other "X" (S-1). Pass the twisted pair through grommet GF and below the chassis. At the other end of the pair, connect one lead to H1 (S-3) and the other to H3 (S-3).
- () Lay the scope over on its left side, and wire the two 4-way tagstrips mounted on the flange of the bottom shield. The front terminal strip will be designated by the letter L (left) and the rear one by R (right). On each strip the tags are numbered left to right (front to rear). Refer to Figure 26 for placement of parts.
- () Connect the free end of the wire previously soldered to NN5 on the SYNC, SELECTOR control to L1 (NS).
- () Strip both ends of a 2½" length of wire, and push one end into the hole in the circuit board marked GR. Solder the wire to the foil. Then connect the other end of the wire to L3 (NS).
- () Similarly, with a 4" length of wire connect hole PL (S-1) to tag R4 (NS).
- () Similarly, with a 1½" length of wire connect hole KA (S-1) to tag R1 (NS).
- () Connect a 1 megohm resistor (BROWN, BLACK, GREEN) from L3 (NS) to L4 (NS).
- () Connect a 10 pF ceramic disc capacitor from L3 (S-3) to L4 (NS).
- () Connect a 470 KΩ resistor (YELLOW, VIOLET, YELLOW) from L4 (NS) to R1 (NS).
- () Connect a .25 μF 400 volt tubular capacitor from L1 (use sleeving) (S-2) to L4 (S-4).
- () Connect a short bare wire from tag F▲ on the electrolytic capacitor (S-1) to R3 (NS).
- () Connect a 150 KΩ resistor (BROWN, GREEN, YELLOW) from R3 (S-2) to R4 (NS).
- () Connect a 33 KΩ resistor (ORANGE, ORANGE, ORANGE) from R4 (NS) to R2 (NS).
- () Connect a .1 μF 250 volt tubular capacitor from R4 (S-4) to R2 (NS).
- () Connect an 820Ω resistor (GREY, RED, BROWN) from R1 (S-3) to R2 (S-3).

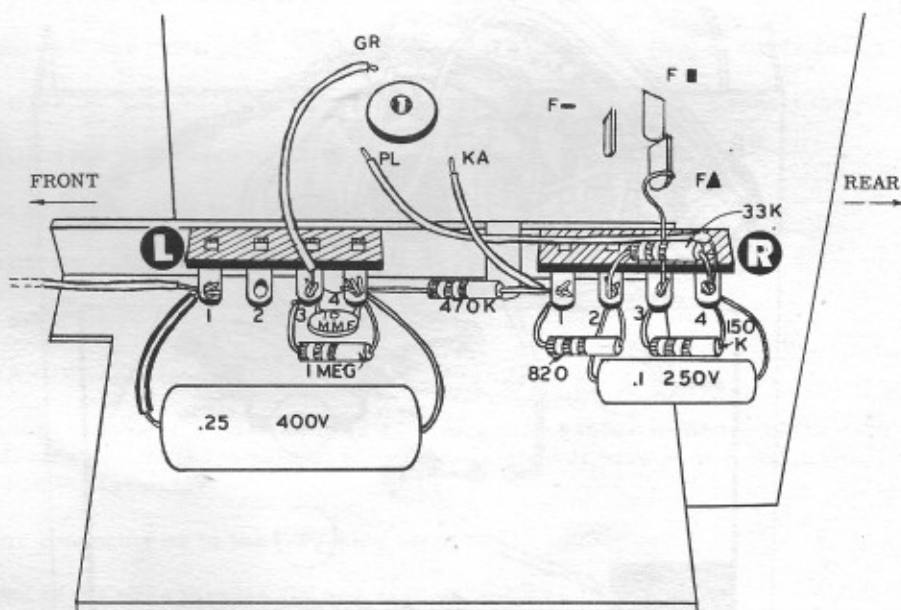
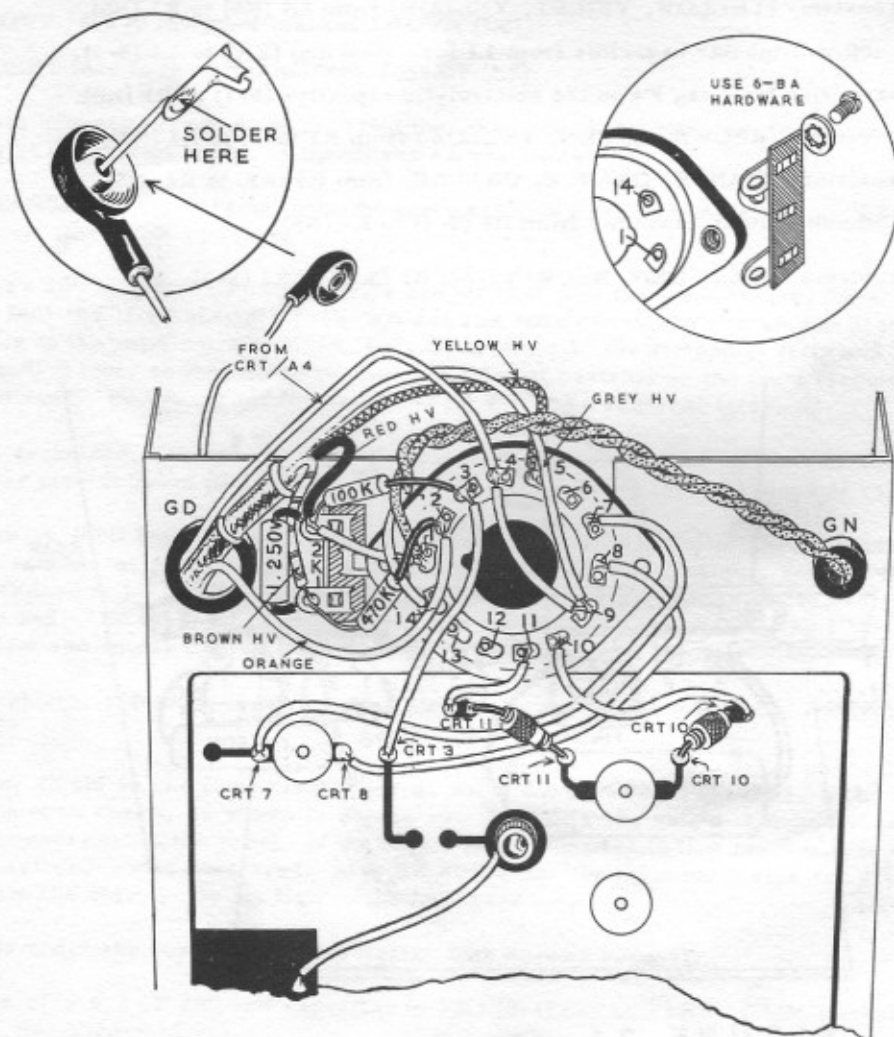
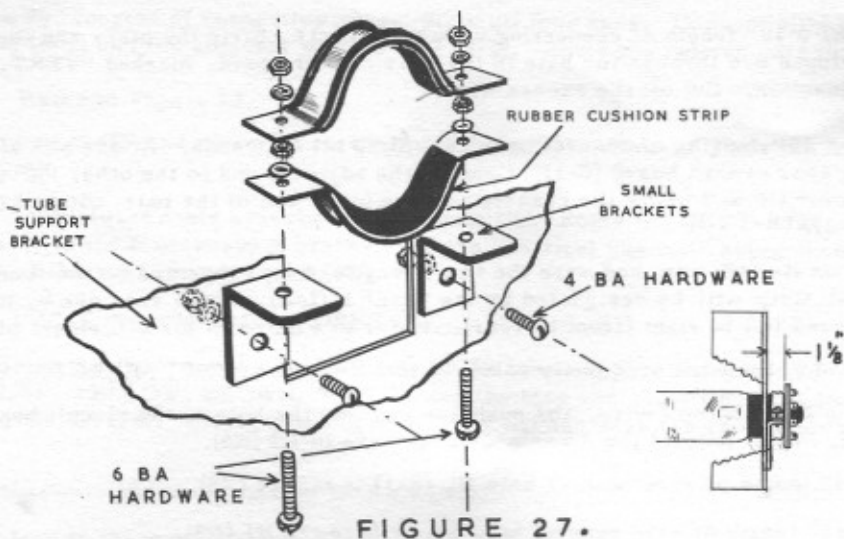

FIGURE 26.



CATHODE RAY TUBE INSTALLATION AND WIRING

- () Mount the two small brackets on the rear side of the tube-support bracket as shown in Figure 27, using 2 - 4BA x 3/8" screws, lockwashers and nuts.
- () Refer to Figure 27. Insert a length of rubber cushion strip over each clamp ensuring that the clamp is seated in the groove, cut off surplus materials.
- () Assemble one half as the lower tube clamp using 2 - 4BA x 3/4" screws, lockwashers and nuts.

CAUTION: Carefully open the carton containing the 1324C cathode ray tube. Handle the tube with reasonable caution, since it has been highly evacuated. Should the envelope be broken the resulting implosion could spray the area with shattered glass with possibly serious consequences. Avoid handling the tube while wearing diamond rings which might scratch the glass. Do not strike the envelope with tools and do not subject it to impact or shock.

- () Slip the screen end of the tube through the panel ring and rest the base on the lower half of the tube clamp. Position the tube with pin 4 straight up and the base about 1.1/8" behind the tube-support bracket. (Figure 27.)
- () Place the other half of the tube clamp over the base and gently tighten down using 2 - 4BA nuts and lockwashers.

Note that pins on this tube are numbered clockwise, starting with the first pin clockwise from the keyway. Refer to Figure 28.

- () Mount a 2-way tagstrip on the 14-contact tube socket CRT, using the tapped hole next to contact 1 of the socket using 1 - 6BA x 5/16" screw and lockwasher.

NOTE: In making connections to socket CRT, leave enough slack in the leads to permit rotating the socket through 10 degrees either way from its present position. This is necessary to level the undeflected horizontal trace on the face of the tube.

- () Carefully fit socket to CRT base.
- () Connect a 0.1 μ F 250 volt tubular capacitor between K1 (use sleeving) (NS) and K2 (use sleeving) (NS).
- () Connect one lead of a 100 K Ω resistor (BROWN, BLACK, YELLOW) to K2 (NS) and the other lead to CRT3 (use sleeving) (NS).
- () Connect a bare wire link (use sleeving) between K2 (NS) and CRT1 (NS).
- () Connect a 470 K Ω resistor (YELLOW, VIOLET, YELLOW) from K1 (NS) to CRT2 (use sleeving) (NS).
- () Route the cable over the CRT socket and form it as shown in Figure 28. Connect the RED HV lead to K2 (S-4).
- () Connect the BROWN HV cable lead to K1 (S-3).
- () Connect the YELLOW HV cable lead to CRT5 (S-1).
- () Connect the GREY HV cable lead to CRT9 (NS).
- () Connect a wire from CRT9 (S-2) to CRT4 (NS).
- () Connect the ORANGE cable lead to CRT2 (S-2).
- () Cut a 15" length of connecting wire and pass 2" through the rubber insulator of the CRT anode connector, see Figure 28. Solder the wire to the metal insert and then gently pull wire back through the insulator until the metal insert is housed in the insulator.
- () Lightly press the connector on to the CRT side contact A4.
- () Pass the free end of the wire through GN and connect to CRT4 (S-2).
- () Take the twisted pair passing through grommet GN. Connect either lead to CRT1 (S-2) and the other lead to CRT14 (S-1).

- () Cut two pieces of connecting wire, each 8" long. Strip all four ends. Do not twist. Connect one lead from CRT7 (S-1) to the tag on valveholder V7 (marked "CRT7") (S-1). Connect the other lead from CRT8 (S-1) to the tag on valveholder V7 marked "CRT8" (S-1). Note: These connections have both been soldered previously in assembling the circuit board. It is not necessary to crimp these leads to the contacts of V7. Simply heat the contact slightly, insert the wire in the solder fillet, remove the iron and hold the lead until the joint cools.
- () Connect a $7\frac{1}{2}$ " lead from CRT3 (S-2) to the point marked "CRT3" (S-1).
- () Connect one of the 33 μ H chokes between the two points on the rear circuit board each marked "CRT10" (S-1). Cut off excess leads.
- () In a similar manner, connect the other 33 μ H choke between the two points each marked "CRT11" (S-1). Cut off excess leads.
- () Connect a $4\frac{1}{2}$ " length of connecting wire between the hole adjacent to the upper point marked "CRT10" (S-1) and the tube socket CRT10 (S-1).
- () In a similar manner, connect a $4\frac{1}{2}$ " length of connecting wire between CRT11 (S-1) and the tube socket CRT11 (S-1).
- () Connect a $4\frac{1}{2}$ " length of connecting wire between the EARTH conductor (S-1) and terminate the other on the Z-axis terminal, see Figure 28.

FINAL ASSEMBLY

IMPORTANT WARNING: MINIATURE VALVES CAN BE EASILY DAMAGED WHEN PLUGGING THEM INTO THEIR VALVEHOLDERS. THEREFORE, USE EXTREME CARE WHEN INSTALLING THEM. WE DO NOT GUARANTEE OR REPLACE MINIATURE VALVES BROKEN DURING INSTALLATION.

Support the underside of the circuit boards when inserting the valves.

- () Insert valves in valveholders as follows:

Valveholder V1 - EC92	Valveholder V6 - 12AU7
Valveholder V2 - ECF80	Valveholder V7 - 12AU7
Valveholder V3 - 12BH7	Valveholder V8 - GZ34
Valveholder V4 - 6J6	Valveholder V9 - 6C4
Valveholder V5 - 12AU7	

- () Insert the 1 amp fused plug in the voltage selector panel at the appropriate voltage tapping to suit your mains supply.
- () Install the 4 skirtless knobs on the following controls:

BRILLIANCE	FOCUS
VERTICAL POSITION	HORIZONTAL POSITION
- () Install the 8 skirted knobs on the other controls. Adjust the knob and tighten the grub screws so that the pointer indicates as follows in the full clockwise position:

VERT. GAIN - 100
VERT. ATTENUATOR - X1
FREQ. SELECTOR - Line between 100 kc and 500 kc
FREQ. VERNIER - 100
HOR. GAIN - 100
PHASE - Last clockwise marking
EXT. SYNC. AMPLITUDE - Last clockwise marking
SYNC. SELECTOR - EXT.

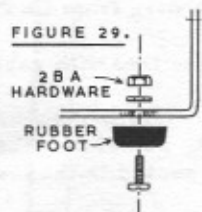

- () Mount the cover plate on the back of the cabinet with a 4BA x $3/8$ " chrome plated screw.
- () Install the handle on the top of the cabinet, using 2 - 2BA x $5/8$ " chrome plated screws, lockwashers and nuts.
- () Install the rubber feet on the bottom of the cabinet as shown in Figure 29.
- () Insert a $5/8$ " rubber grommet in hole at rear of cabinet.

- () Assemble the pair of test leads, one RED and one BLACK, as shown in Figure 30.

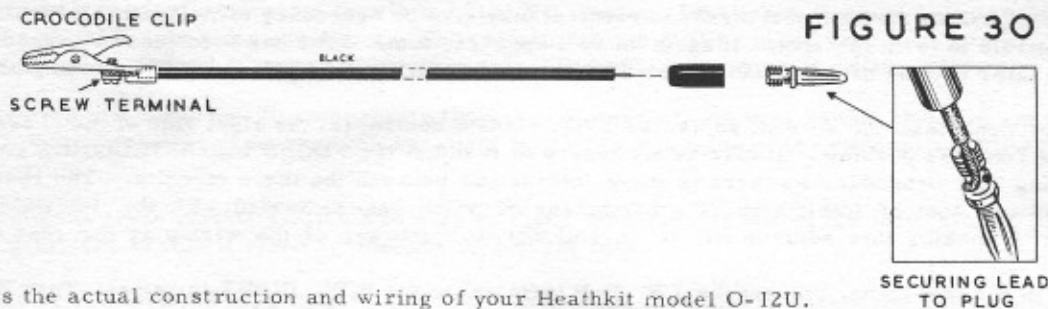

This completes the actual construction and wiring of your Heathkit model O-12U.

Before attempting to operate the instrument, recheck each step in the wiring against the pictorial diagrams. It is sometimes helpful to mark each lead on the diagram with a coloured pencil as it is checked. This precludes the possibility of missing a connection. When satisfied that the wiring is complete and correct, proceed with the adjustment and testing of the instrument.

CAUTION: The voltages in the instrument are dangerous. Extreme care should be exercised whenever the instrument is connected to the AC mains without being installed in its case. DO NOT connect the mains lead to an AC outlet until you have read and fully understand the following instructions on testing the oscilloscope.

Some of the adjustments which must be made on the instrument cannot be performed with the cabinet in place. Whenever the O-12U is operated without the cabinet, be sure to remove the mains lead from the outlet before attempting to change position of the scope on the bench. Some of the highest voltages in the circuit appear on the BRILLIANCE and FOCUS control terminals, just below the top edge of the panel. It is easy to touch one of these terminals when moving the O-12U.

ADJUSTING THE OSCILLOSCOPE

- () Set the controls as follows BEFORE connecting the mains lead to an AC outlet:

BRILLIANCE	- Fully anti-clockwise
FOCUS	- At approximate centre of rotation
HORIZONTAL POSITION	- At approximate centre of rotation
VERTICAL POSITION	- At approximate centre of rotation
VERT. GAIN	- Fully anti-clockwise
HOR/FREQ. SELECTOR	- Fully anti-clockwise
HOR. GAIN	- 0
VERT. ATTENUATOR	- X100
FREQ. VERNIER	- 50
PHASE	- At approximate centre of rotation
EXT. SYNC. AMPLITUDE	- Fully anti-clockwise
SYNC. SELECTOR	- EXT.
SPOT SHAPE	- At approximate centre of rotation

- () Connect the mains lead to a 200-250 volt 40-60 cycle AC outlet. Ensure that the fused plug is in the appropriate tap. **CAUTION:** This instrument will not operate and may be seriously damaged if connected to a DC supply or to a supply other than that mentioned.
- () Turn the BRILLIANCE control fully clockwise. The pilot light should light and all valve heaters should glow red. Allow about one minute for the valve heaters to reach operating temperature.
- () Watch the screen of the CR tube carefully until a green spot appears. Reduce the brightness of the spot at once by rotating the BRILLIANCE control anti-clockwise. Now adjust the FOCUS control to reduce the size of the spot to a minimum.

CAUTION: DO NOT PERMIT A HIGH INTENSITY SPOT TO REMAIN STATIONARY ON THE SCREEN FOR ANY LENGTH OF TIME. THIS MAY DESTROY THE FLUORESCENT MATERIAL ON THE SCREEN AND LEAVE A DARK SPOT.

- () Rotate the HORIZONTAL POSITION control and notice that the spot moves horizontally across the screen. Now, using the VERTICAL POSITION control, move the spot up and down. Adjust these two controls so that the spot is centred on the screen.

If no spot appears, rotate both the HORIZONTAL and VERTICAL POSITION controls simultaneously, since the controls may position the spot well off the screen. It may also be necessary to readjust the FOCUS and BRILLIANCE controls to form the spot. If again no spot appears, some error has been made in assembly or wiring. Refer to a later section of this manual, entitled IN CASE OF DIFFICULTY, for a fault finding procedure.

- () With the spot centred on the screen, adjust the SPOT SHAPE control (at the right side of the chassis) to produce the spot as round as possible. It may be necessary to readjust the FOCUS and BRILLIANCE controls several times during this procedure as there is some interaction between the three circuits. The result should be a sharply defined spot of small size, the brightness of which can be varied with the BRILLIANCE control. CAUTION: In making this adjustment, be careful not to touch any of the wiring at the rear of the chassis.
- () Using one of the test leads, connect the 1 V. P-P terminal to the HOR. INPUT terminal. Turn the HOR. GAIN control clockwise. The spot should now become a horizontal line, whose length increases to a maximum of about $1\frac{1}{2}$ " as the HOR. GAIN control is advanced. If the trace is not level, indicate the slope of the line with a wax pencil or crayon on the glass face of the CR tube. Turn off the power, loosen the tube clamp on the base of the CR tube and rotate it slightly until the markings are horizontal. Tighten clamp and check trace to see that it is level. CAUTION: DO NOT ATTEMPT TO MAKE THIS ADJUSTMENT WITHOUT TURNING OFF THE INSTRUMENT. SOME SOCKET CONTACTS ON THE CR TUBE HAVE A POTENTIAL OF APPROXIMATELY 1200 VOLTS; CONTACT TO THESE TERMINALS COULD EASILY BE FATAL.
- () Next, connect the test lead from the 1 V. P-P terminal to the VERT. INPUT terminal. Rotate the VERT. GAIN control clockwise and note that the trace is now vertical and again is controlled in length by the setting of the control. Switch the VERT. ATTENUATOR control to X10. The line now can be extended to the same length at a fairly low setting of the VERT. GAIN control. Try the X1 position and notice that the same height can be obtained with a very small amount of vertical gain.
- () Set the SYNC. SELECTOR switch to the +INT. position, the HOR. GAIN control to 30, the VERT. ATTENUATOR switch to X10 and the VERT. GAIN control to 100. Now set the HOR./FREQ. SELECTOR to the line between 10 and 100 and adjust the FREQ. VERNIER to obtain a pattern consisting of four complete sine waves similar to that shown in Figure 31. This check indicates that the time base generator is operating normally at a frequency of 50/4 or $12\frac{1}{2}$ cycles per second. Reduce the HOR. GAIN setting if necessary. The breaks are caused by the fields of the power transformer. This will not be present with the external signal.
- () Disconnect the test lead from the 1 V. P-P terminal. Turn off the power and connect the free end of the test lead to the excess lead from the HOR. IN on the rear circuit board. Set the FREQ. SELECTOR to the line between 1000 and 10 K and the FREQ. VERNIER to 0. Now turn on the power. The trace should now be similar to that in Figure 32A or B. Reduce both gain control settings so that the trace is about 2" long.

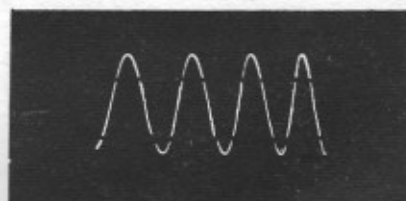

FIGURE 31

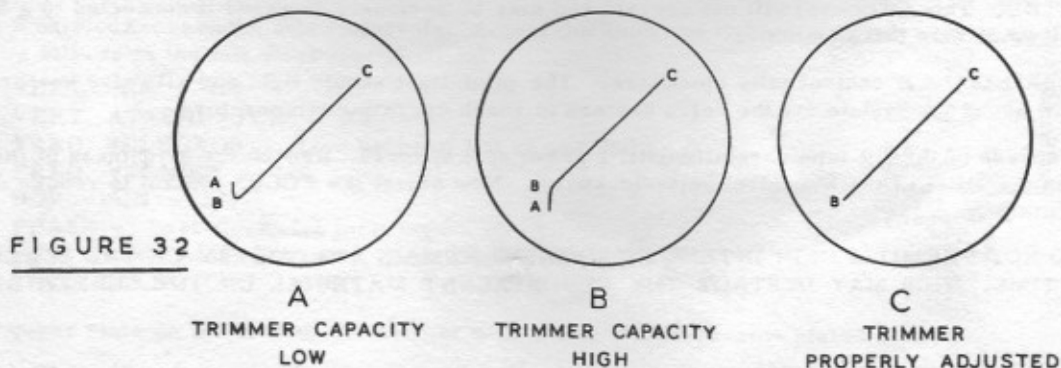

FIGURE 32

- () With the VERT. ATTENUATOR switch in the X10 position, adjust trimmer TT until the AB portion of the trace disappears and only a straight sloping line is left. (TT is the front trimmer on the left panel bracket.)

- () Switch the VERT. ATTENUATOR switch to the X100 position and adjust trimmer UU to obtain the same result. In this adjustment, you will notice that the slope of the BC portion of the trace is more nearly horizontal because of the lower vertical gain being employed. The adjustment can still be made very accurately. Turn power off and disconnect the test lead from rear circuit board. Clip off excess wire at "HOR. IN".

The adjustments just made are to compensate the vertical input attenuators so that they are not frequency conscious. This compensation preserves the excellent frequency response of the vertical amplifier even with high input attenuation.

- () Carefully trim the green plastic graticule to size so that it slips snugly within the foam plastic lined panel ring. Insert the graticule so that it rests against the face of the tube.
- () Take the spring retainer and close together with the thumb and forefinger. Insert the spring into the panel ring so that it fits against the graticule and release pressure.
- () The chassis should now be installed in the cabinet. Pass the mains lead through the hole in the back of the cabinet, then slide the chassis in and fasten it in place using 2 - 4BA x 3/8" chrome plated screws through the back of the cabinet into the tapped pillars at rear of the chassis.

This completes the construction and adjustment of your Heathkit model O-12U Oscilloscope.

OPERATION OF THE OSCILLOSCOPE

The operation of an oscilloscope and its many controls is quite simple once the basic principles are clear.

The controls can be divided into groups with specific functions.

Two knobs, marked BRILLIANCE and FOCUS, control the quality of the trace. The BRILLIANCE control adjusts the brightness and the FOCUS control sharpness of the trace on the oscilloscope screen.

Two knobs, marked VERTICAL POSITION and HORIZONTAL POSITION, control the location of the trace on the screen. Turning the vertical knob shifts the trace up or down and the horizontal knob moves the trace to left or right.

One knob, marked HOR. GAIN, varies the width of the display on the screen.

Two knobs, marked VERT. GAIN and VERT. ATTENUATOR, control the height of the display on the screen.

The PHASE knob controls the phase shift of the line-frequency voltage used for sinusoidal sweep.

Three knobs, marked HOR/FREQ. SELECTOR, FREQ. VERNIER and EXT. SYNC. AMPLITUDE, control the operation of the time base generator. The selector switch and vernier control permit selection of a suitable sweeping rate to provide a clear display. The EXT. SYNC. AMPLITUDE control operates only on external synchronisation to adjust the voltage input to the synchronising circuit.

The HOR/FREQ. SELECTOR switch performs the following additional functions:

EXT. INPUT: The HOR. INPUT terminal is connected directly to the input grid of the horizontal amplifier system. The time base generator is non-operating.

LINE SW: Line frequency voltage, controlled in phase by the PHASE control, is applied to the horizontal amplifier system. The sweep thus applied is sinusoidal in wave-form.

The SYNC. SELECTOR switch operates as follows:

- and + INT: The time base generator is operating, providing saw-tooth sweep at any frequency within its range, synchronised with the signal at the VERT. INPUT terminal.

LINE: The time base generator is operating, providing saw-tooth sweep at any frequency within its range, but synchronised with the line frequency or its harmonics.

EXT: The time base generator is operating, providing saw-tooth sweep at any frequency within its range, but synchronised with any signal applied to the EXT. SYNC. terminal.

The 1 V P-P terminal supplies a voltage for establishing the overall gain of the vertical amplifier. When this voltage is applied to the VERT. INPUT terminal and the VERT. GAIN control and VERT. ATTENUATOR switch are set for a given measured vertical deflection on the graticule, it becomes a simple matter to determine the peak-to-peak value of any unknown voltage. For example; a specification refers to a particular wave-form, designating the normal peak-to-peak voltage as 50 volts. Connect the 1 V P-P terminal to the VERT. INPUT terminal. With the VERT. ATTENUATOR switch in the X1 position, adjust the VERT. GAIN control for a deflection of say, 4 cm. on the graticule. Do not touch the VERT. GAIN control again until the measurement is completed. Disconnect the calibrating voltage and apply the unknown voltage to the VERT. INPUT terminal. Set the VERT. ATTENUATOR switch to the X100 position. Now, a 4 cm. deflection indicates a peak-to-peak voltage of 100 volts. (With the VERT. ATTENUATOR Switch in the X10 position, it would indicate 10 volts.) Adjust the sweep controls to lock the wave-form and adjust the positioning controls for convenient vertical measurement. Observe that the unknown voltage shows a peak-to-peak deflection of 2 cm. representing 50 volts.

The TB OUTPUT terminal provides saw-tooth voltages at the lower time base speeds for controlling other instruments such as frequency-swept oscillators.

NOTES ON THE OPERATION OF THE OSCILLOSCOPE

One of the outstanding features of this instrument is the ease with which the sweep may be synchronised with the incoming signal. You will notice that the EXT. SYNC. AMPLITUDE control has no effect at any setting of the SYNC. SELECTOR switch except the EXT. position. The amplitude control is unnecessary in the other positions because of the built-in sync. limiting circuit. This circuit makes synchronisation easily adjustable by the FREQ. VERNIER control. Settings of this control may become quite critical at low vertical gain settings and very high frequencies.

When operating on external synchronisation, the EXT. SYNC. AMPLITUDE control should be set just above the lowest setting which will give the desired synchronisation.

At maximum gain settings, the sensitivity of the amplifiers is very high. Therefore, without a signal source connected to the input terminal, stray pickup may produce patterns on the screen. This is equivalent to the noise obtained from high gain audio amplifiers when the pickup or the microphone is disconnected. Such behaviour is a normal characteristic of the instrument and does not interfere with proper operation.

At low sweep rates (30 cycles or less) the screen has insufficient persistence to provide a steady picture. This flicker is inherent with medium persistence screens at low sweep rates.

In addition to the above notes, there are several other effects which may be noticed under actual operation of the scope. All the following characteristics are normal to the O-12U design and should cause no concern:

1. At extreme sweep rates and with fairly high intensity settings, retrace blanking is not complete. Some indication of the retrace, particularly at the left side, is to be expected.
2. When adjusting for minimum spot size, some deflection of the beam may take place due to external magnetic fields. This condition will remain, even with both horizontal and vertical gain controls set to minimum. It is caused by magnetic fields generated by other electrical equipment in proximity to the oscilloscope and the extent of such fields is often amazing. These extraneous fields can be identified by observing whether the spot shape, adjusted for minimum size, seems to change with the orientation of the instrument. To check, turn the scope cabinet around the vertical axis. Soldering guns, fan motors, power transformers, voltage regulators and conduit carrying heavy AC conductors are particularly bad offenders in this respect. In the past, such deflections have been swamped out by the relatively large spot size which could be resolved. With present cathode ray tube designs and improved circuitry, the effect is much more noticeable.
3. The same magnetic deflection mentioned above may cause a "breathing" or hum-modulation effect on any wave-form displayed, if the time base circuit is operating near the line frequency or a harmonic of it. Although not so easy to identify, one can usually spot this effect by varying the sweep speed slightly to present one less or one more full cycle in the display; the "breathing" rate will change and may even become evident as a dual trace under some conditions.
4. Vertical positioning range is deliberately limited to ± 4 cm. from centre, while horizontal positioning has been extended to several times screen width at normal sweep frequencies. This limited vertical positioning is required to maintain proper operating conditions in the vertical deflection amplifier and no attempt to extend it should be considered.

5. You will note that it is impossible to turn the signal entirely off with the vertical gain control. This has been done purposely in order to force the user of the scope to reduce gain with the vertical attenuator switch to prevent overloading the input stage of the vertical amplifier.
6. A slight overshoot or ringing effect may be noticed with square-wave inputs at frequencies of 100 kc and higher. This effect should not exceed 10%. Bear in mind, however, that square-wave generators are prone to create this condition themselves. Do not condemn your oscilloscope until this possibility has been checked.
7. As time base sweep rates are increased, particularly above 200 kc, a reduction in available sweep amplitude will be noted. This is a function of the falling frequency response of the horizontal amplifier and is normal. At maximum sweep rates, at least 4" of horizontal deflection should be obtained with full horizontal gain. Bear in mind that under these conditions, the time base generator is operating at radio frequencies and may be heard on adjacent radio receivers.
8. Some de-focusing may be experienced at the extreme right-hand edge of the trace. This condition does not indicate a fault in the CRT, and will in no way interfere with normal oscilloscope operation.
9. If the scope is operating with a total horizontal sweep width of 4", for example, and the horizontal gain setting is increased to give a much greater sweep width, the apparent intensity of the trace will be reduced. This action is normal. It is caused by the fact that the trace intensity is inversely related to the writing speed of the electron beam. As the sweep width is increased, the writing speed increases also and the intensity will drop.

IN CASE OF DIFFICULTY

If the test procedure described does not produce the expected results, the following procedure is recommended:

1. Check the wiring against the pictorial diagrams. Follow each wire in the instrument and check the connections at each end for good solder joints and for termination at the proper points. We cannot over emphasise the importance of good solder connections. A good solder connection will appear bright. If a connection is dull looking, we suggest it be resoldered. Checking each lead off in coloured pencil on the pictorial as it is compared with the instrument will sometimes reveal an error consistently overlooked. Sometimes having a friend check over the wiring will help to locate a wiring error which may be overlooked repeatedly by the kit builder. Mistakes in wiring are responsible for the majority of troubles experienced by kit builders.
2. Check the voltages at the valveholder tags. The readings should compare with the table on Page 40, within 25%. These measurements were made with a Heathkit V-7A/UK having an input resistance of 11 megohms. Voltage checks made with instruments of other input characteristics may vary greatly. Should a discrepancy in voltage readings show up, carefully check the components associated with that valve.
3. Check the values of the component parts. Be sure that the correct part has been wired into the circuit, as shown in the pictorial diagram and as called up in the wiring instructions.
4. If the dot moves off the face of the CRT immediately after the kit warms up, and cannot be brought back by adjusting the positioning controls, it is generally caused by a defective deflection amplifier valve. If the trace drifts up or down, check the 12BH7 at V3. If the drift is right or left, check the ECC82 (12AU7) at V7. Other probable causes are incorrect or defective anode load resistors, for these stages - the 2.7 K Ω 2 watt and 1 K Ω 1 watt resistors to V3, and the 33 K Ω 1 watt resistors to V7.
5. If you are unable to obtain straight diagonal lines when adjusting the vertical trimmers, please refer to Figure 32 on Page 34 of your O-12U manual. The patterns shown there present a perfectly straight line between points B and C on the traces. Some constructors have raised questions on this point, stating that they cannot obtain a straight line between B and C. This is perfectly normal. The indication which is significant is that portion of the trace between A and B. The intention of the adjustment is to reduce this portion of the trace to a point at the lower end of the trace, thus indicating neither overshoot or slow rise time on the sharp wave-front of the saw-tooth generated by the time base generator. If the remaining portion of the line is not quite straight, a readjustment of the sweep frequency will probably locate a point where the effect is changed radically. This variation is due to minor phase shift relationships in the amplifier circuits, not to defective or improper compensation.

6. If you are troubled with hum or ripple when the O-12U is operated with shorted vertical input terminals, please make the following checks:
- A. To determine if the hum level is abnormal, short the VERT. INPUT terminal to EARTH, increase the VERT. GAIN control to 100, and set the VERT. ATTENUATOR to X1. The total vertical trace width should not exceed 1/16" peak-to-peak. With the input terminals open-circuited and not shielded, this deflection will increase several times because of the normal pickup of the input circuit. This condition is perfectly normal, and is typical of any high-gain, high-impedance amplifier circuit.
 - B. If the shorted-input condition results in a trace more than 1/16" in vertical width, connect a shorting lead between CRT10 and CRT11 on the cathode ray tube socket. This will eliminate any electrostatic deflection of the beam, which is the normal method by which the scope operates. If the trace height then appears to be normal - that is, in the order of 1/16" or so - the difficulty lies in the vertical deflection amplifier circuits and may be isolated readily by tracing back through the various stages until the source of hum or noise is located.
 - C. If, with CRT10 and CRT11 shorted, the vertical width of the trace exceeds 1/16" the deflection or ripple is caused by magnetic deflection of the beam by stray magnetic fields passing through the beam path. This is the same type of deflection used in most modern television receivers.

The magnetic field creating the deflection is almost always a composite of many separate field patterns. A portion of this field is created by the O-12U power transformer, but the relation between the CR tube and transformer has been carefully established so that the sensitive portions of the tube structure are located in a null of the magnetic field surrounding the transformer. Severe overloading of the power transformer will upset this balanced condition, however. The greatest sources of trouble in this respect are magnetic fields from equipment external to the scope itself. Anything which consumes power at mains frequency creates a magnetic field. The worst offenders are those equipments which draw a considerable amount of current - soldering irons, soldering guns, AC motors, electric heaters and similar items.

Figure 33A shows the general type of wave shape caused by external magnetic fields. Notice the semi-sawtooth wave shape. It is possible to change the wave shape by simply rotating the oscilloscope physically about any of its axes. Figure 33B, for example, was obtained by tilting the scope about 45 degrees to its left. Observe that now the ripple has actually reduced itself in height, but appears to sweep back on itself for about 30% of its cycle.

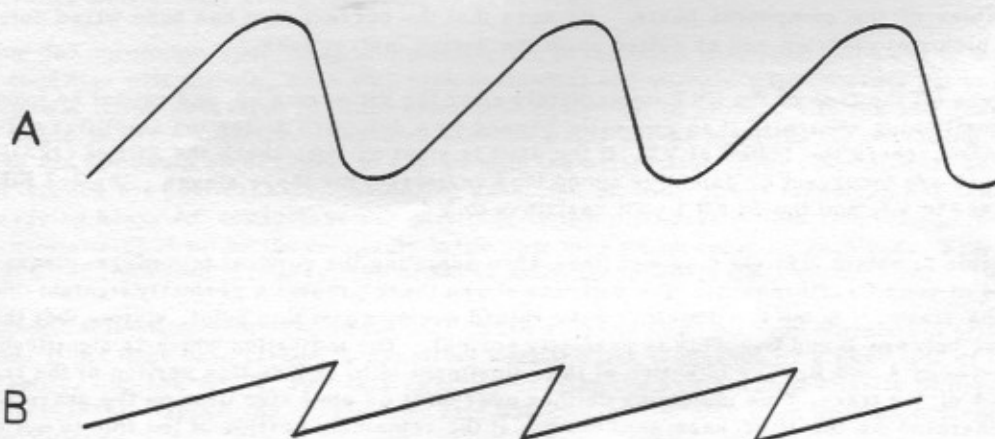

FIGURE 33.

Variations in the ripple appearance with changes in physical location of the scope are definite proof that the deflection is not caused by a defect in the O-12U, and no known way exists for eliminating the difficulty except by complete shielding of the entire cathode ray tube from socket to face with a high permeability metallic shield. Such a shield would cost at least £8. 0. 0d. for the 1324C, and is an obvious impossibility in a kit selling for as low a price as the O-12U.

Fortunately, interference of this kind is usually small in amplitude and presents no problem to the average user. A little judicious experimenting will isolate the principal offender creating the field. Physical separation is in general a quick and easy solution to the problem.

7. Should the procedure as outlined fail to correct your difficulty, write to Daystrom Ltd. describing the nature of the trouble by giving all possible details, including voltage readings obtained and other indications you may have noticed. We will try to analyse your trouble and advise you accordingly. No charge is made for this service.

IN ALL CORRESPONDENCE, REFER TO THIS INSTRUMENT AS THE MODEL O-12U OSCILLOSCOPE.

BIBLIOGRAPHY

While many issues of the popular radio and service magazines have carried excellent articles on the construction and application of oscilloscopes, and their reading is highly recommended, we also suggest the following excellent books:-

The Oscilloscope at Work	-	Haas and Hallows
The Oscilloscope and its Applications	-	Philips Electrical Ltd.
Modern Oscilloscopes and their Uses	-	Ruiter
How to Service Radios with an Oscilloscope	-	Sylvania
How to use the CR Oscilloscope in Servicing Radio and TV	-	Hickok
The Cathode Ray Tube at Work	-	Rider
Basic Electronic Test Instruments	-	Turner
Radio Handbook	-	Editors and Engineers
Radio Amateurs Handbook	-	A. R. R. L.
Encyclopedia on Cathode Ray Oscilloscopes and Their Uses	-	Rider and Uslan

CONTROL SETTINGS FOR VOLTAGE CHECKS

BRILLIANCE	-	Minimum rotation for barely visible spot
FOCUS	-	Minimum spot size
VERT. POSITION	-	Spot centred
HOR. POSITION	-	Spot centred
VERT. ATTENUATOR	-	X100
VERT. GAIN	-	10
HOR. GAIN	-	0
HOR/FREQ. SELECTOR	-	10-100
FREQ. VERNIER	-	100
PHASE	-	Fully clockwise
EXT. SYNC. AMPLITUDE	-	Fully anti-clockwise
SYNC. SELECTOR	-	INT.

VOLTAGE TABLE

VALVE TYPE	Pin 1	Pin 2	Pin 3	Pin 4	Pin 5	Pin 6	Pin 7	Pin 8	Pin 9
V1 EC92	125	N N	H H	H H	NC NC	4	10.6	- -	- -
V2 ECF80	58	-0.75	108	H H	H H	92	0	0	-0.8
V3 12BH7	(1) 280	(1) 27	(1) 42	H H		(1) 280	(1) 35	(1) 42	H H
V4 6J6	75	(2) 16.5	H H	H H	2	0 0	3.2	- -	- -
V5 ECC82(12AU7)	100	75	85	H H		80	(2) -2.4	0 0	H H
V6 ECC82(12AU7)	125	15	64	H H		78	N N	2.6	H H
V7 ECC82(12AU7)	(1) 215	(1) 92	(1) 96	H H		(1) 245	(1) 44	(1) 96	H H
V8 GZ34	NC NC	HR HR	NC NC	360 AC	NC NC	360 AC	NC NC	HR HR	- -
V9 6C4	138	NC	H H	H H	138	-3.5	0 0	- -	- -
CRT	HVH HVH	(3) -1100	-1220	(5) 300	(4) -900	NC NC	(1) 215	(1) 245	(5) 300
	Pin 10	Pin 11	Pin 12	Pin 13	Pin 14				
1324C	(1) 280	(1) 280	NC NC	NC NC	HVH HVH				

All voltages are positive with respect to chassis unless indicated otherwise.

H - AC voltage this point to chassis: 3.15 volt. Between points: 6.3 volt.

HR - AC voltage between points: 5 volt. CAUTION: These terminals + 410 volts with respect to chassis.

HVH - AC voltage between points: 6.3 volt. CAUTION: These terminals - 1200 volts with respect to chassis.

(1) - Varies with position control setting.

(2) - Varies with HOR/FREQ. SELECTOR and FREQ. VERNIER setting.

(3) - Varies with BRILLIANCE setting.

(4) - Varies with FOCUS setting.

(5) - Varies with SPOT SHAPE setting.

NC - No connection.

- - No reading, or no contact on socket.

N - Not significant.

NOTE: When construction and adjustment of your O-12U has been satisfactorily completed, it is worthwhile noting voltage readings for future reference in the spaces provided.

REPLACEMENTS

Material supplied with Heathkits has been carefully selected to meet design requirements and ordinarily will fulfill its function without difficulty. Occasionally, however, improper instrument operation can be traced to a faulty valve or component. Should inspection reveal the necessity for replacement, write to Daystrom Ltd. and please supply all of the following information:-

- A. Thoroughly identify the part in question by using the part number and description found in the Manual parts list.
- B. Identify the type and model number of the kit in which it is used.
- C. Mention the order number and date of purchase.
- D. Describe the nature of defect or reason for requesting replacement.

Daystrom Ltd. will promptly supply the necessary replacements. Please do not return the original component until specifically requested to do so. Do not dismantle the component in question as this will void the guarantee. If valves are to be returned, pack them carefully to prevent breakage in shipment, as broken valves are not eligible for replacement. This replacement policy does not cover the free replacement of parts that may have been broken or damaged through carelessness on the part of the kit-builder.

SERVICE

If the completed instrument should fail to function properly and attempts to find and cure the trouble prove ineffective, the facilities of Daystrom's Service Dept. are at your disposal. Your instrument may be returned carriage paid to Daystrom Ltd., Gloucester, and the Company will advise you of the service charge where not covered within the terms of the guarantee (i. e. a faulty component supplied by us). **THIS SERVICE POLICY APPLIES ONLY TO COMPLETED INSTRUMENTS CONSTRUCTED IN ACCORDANCE WITH THE INSTRUCTIONS AS STATED IN THIS MANUAL.** Instruments that are modified in design will not be accepted for repair. Instruments showing evidence of acid core solder or paste fluxes will be returned not repaired.

Daystrom Ltd. is willing to offer its full co-operation to assist you in obtaining the specified performance level of your instrument. Factory repair service is available or you may contact the Engineering Consultation Department by mail. For information regarding possible modification of existing kits, it is suggested that you refer to any one or more of the many publications that are available on all phases of electronics. Although Daystrom Ltd. sincerely welcomes all comments and suggestions, it would be impossible to design, test, evaluate and assume responsibility for proposed circuit and layout changes for specific purposes. Therefore, such modifications must be made at the discretion of the kit builder according to information which will be much more readily available from some local source.

SHIPPING INSTRUCTIONS

Before returning a unit for service, be sure that all parts are securely mounted.

ATTACH A LABEL TO THE INSTRUMENT GIVING
NAME, ADDRESS AND TROUBLE EXPERIENCED.

Pack in a rugged container, preferably wood, using at least three inches of shredded newspaper, wood wool or plastic cushioning material on all sides. **DO NOT DESPATCH IN THE ORIGINAL KIT CARTON AS THIS CARTON IS NOT CONSIDERED ADEQUATE FOR SAFE SHIPMENT OF THE COMPLETED INSTRUMENT.** Note that a carrier cannot be held liable for damage in transit if packing, in HIS OPINION, is insufficient.

PRICES: All prices are subject to change without notice.

MODIFICATIONS TO SPECIFICATIONS: Daystrom Ltd. reserves the right to discontinue instruments and to change specifications at any time without incurring any obligation to incorporate new features in instruments previously sold.

* * * * *

The Heathkit builder is again strongly urged to follow step-by-step the instructions given in this Manual to ensure successful results. Daystrom Ltd. assumes no responsibility for any damages or injuries sustained in the assembly or handling of any of the parts of this kit or the completed instrument.

SOME OSCILLOSCOPE APPLICATIONS

As mentioned in the introduction to this manual, the cathode ray oscilloscope is a most versatile device. It has the unique ability to measure the basic electrical quantities and, more important, to show the relationships between as many as three of these quantities at any one time. Or, it can relate one or two of the variables against a controlled time reference. Therefore, it can indicate such characteristics as frequency, phase shift, and wave-form.

By the use of supplementary devices, called transducers, a great variety of other physical attributes can be investigated with the oscilloscope. These transducers are used to convert sound, heat, light, stress or physical movement into electrical impulses. The impulses can be studied by displaying them on the screen of the oscilloscope.

The following portion of this manual is simply to familiarise you with the basic applications of your oscilloscope. Each one of the uses described is well within the capabilities of the Heathkit model O-12U Oscilloscope.

WAVEFORM INVESTIGATION

Probably the major use of most oscilloscopes is in the study of recurrent or transient variations in an electrical quantity. Since the oscilloscope is a voltage-operated device, these variations must be first converted into changes in voltage.

It is common practice to apply the signal voltage to the vertical input to the oscilloscope. By means of attenuators and amplifiers, this voltage is made to displace vertically the electron beam in the cathode ray tube. At the same time, the beam is being swept horizontally by the time base generator within the instrument. The sweep frequency is normally a sub-harmonic or simple fraction of the signal frequency. Therefore, more than one complete cycle of the signal is shown on the screen.

With this brief background, we have described below the more common applications of the oscilloscope in studying wave-forms.

Testing Audio Amplifiers and Circuits.

Figure 34 shows the conventional set-up of equipment for this application. The audio generator should be capable of producing a pure sine wave with very low harmonic distortion. The load resistor should match the output impedance of the amplifier. The usual practice is to perform all tests at an input voltage sufficient to develop a reference power output. This prevents over-loading of any portion of the amplifier and consequent inaccuracies in measurements.

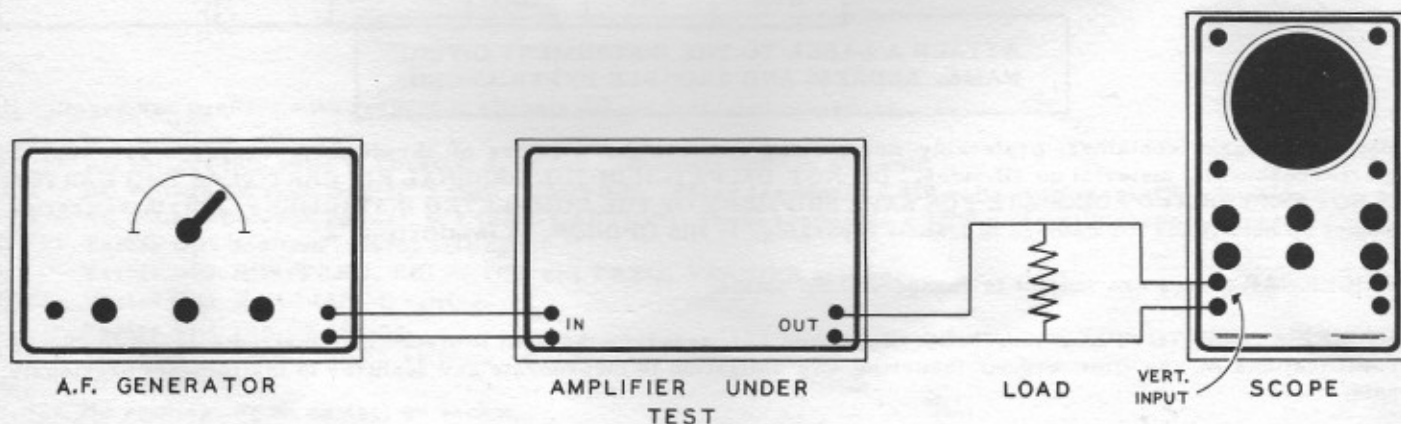

FIGURE 34.

Figure 35A shows serious flattening of one peak, representing about 10% harmonic distortion. This condition may be caused by incorrect bias on any stage, or by an inoperative valve in a push-pull stage. Figure 35B indicates third harmonic distortion, a particularly objectionable fault. Figure 35C shows flattening of both peaks, usually an indication of overload somewhere in the circuit.

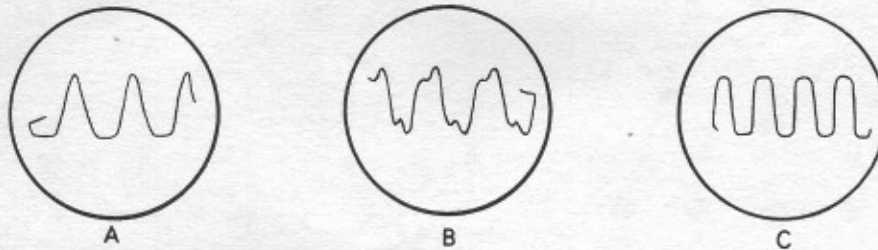

FIGURE 35

Although the use of sine wave input tells us a lot about an amplifier, the use of a square-wave input waveform gives a very accurate and extremely sensitive indication of the performance of the system with respect to both amplitude distortion and phase shift. Assume that we apply a wave of the form shown in Figure 36A. In a theoretically perfect amplifier, the output waveform would be an exact duplicate except at a greater power level as determined by the gain of the amplifier. Actually, the distortion of this waveform as shown by the scope tells a great deal about the amplifier at frequencies considerably separated from the test frequency. If the high frequency performance of the amplifier is excellent, the front of the square wave will be sharp cornered and clean. A distortion similar to that shown in Figure 36B indicates poor high frequency response, which may be amplitude distortion, phase shift, or both. We may assume, therefore, that the shape of the rising portion of the waveform indicates the ability of the amplifier to faithfully reproduce high frequencies. Conversely, the slope of the flat-top portion of the wave indicates the performance of the amplifier in the low frequency range. Figure 36C is the characteristic indication of an amplifier with a poor low frequency response.

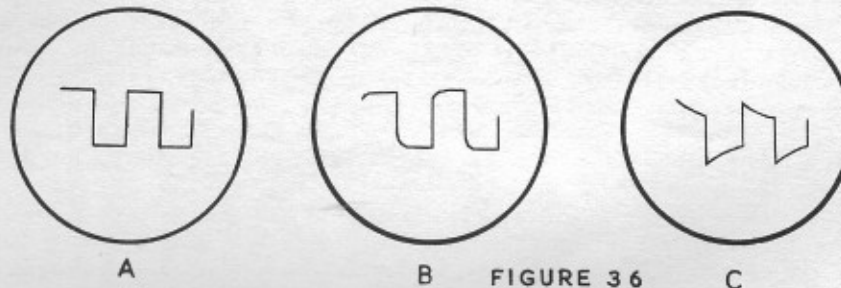

FIGURE 36

Further discussion of this method is beyond the scope of this manual. Interested readers are referred to the bibliography for further sources.

Servicing Television Receivers.

Servicing television receivers is a rapidly expanding application of the cathode ray oscilloscope. Each of the following basic uses requires some additional equipment, but none of them can be performed without using the oscilloscope. This particular field has been given specific attention in the design of the Heathkit Model O-12U.

1. Alignment of a television receiver is virtually impossible without the use of an oscilloscope and a television alignment generator. This generator supplies an RF signal over all VHF frequencies involved in a modern television receiver operation. The signal can be frequency-modulated at 50 cycles per second with a deviation of several megacycles. The generator also provides a 50 cycle sweep voltage, controllable in phase, to drive the horizontal deflection amplifiers in the oscilloscope. It also provides a blanking system which cuts off the RF output of the generator during one-half of its operating cycle. In effect, the generator output starts at a base frequency and sweeps at a uniform rate from the base frequency to a frequency several megacycles higher. The oscillator output is then cut off, and the cycle is repeated. The vertical input to the scope is driven by the voltage developed at the input to the video amplifier. Since this voltage varies in exact accordance with the gain of the RF and/or IF amplifier stages

over the frequency range being swept, the trace on the scope screen is actually a graphic representation of the response of the amplifiers being tested.

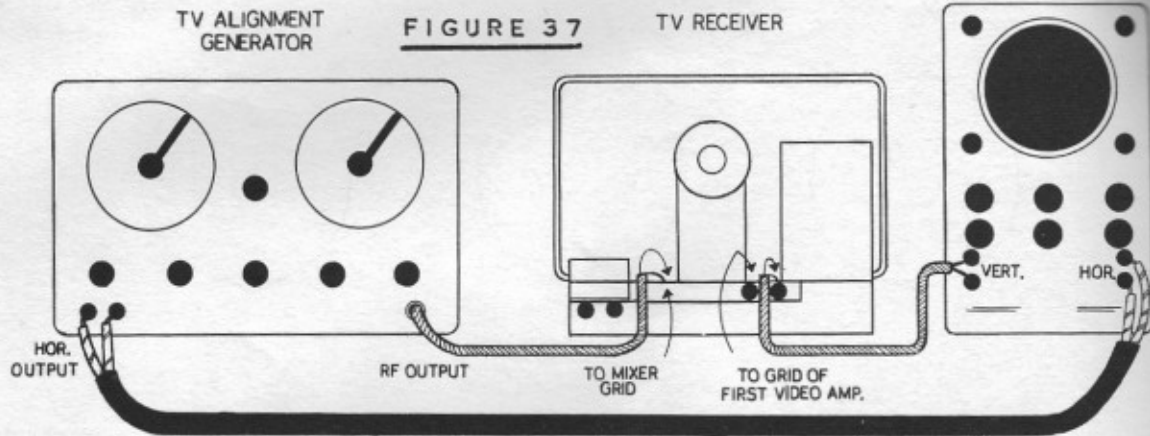

Figure 37 outlines the connections between the alignment generator, the receiver and the oscilloscope. The exact procedure for alignment varies greatly. This information is generally available in the manufacturer's service information. Usually, a drawing of the desired response curve is given, together with a sequence of adjustments to roughly approach the desired pattern. Final adjustments are made whilst watching the trace on the oscilloscope.

2. The waveform of the complex television picture signal as it is passed through the receiver is undoubtedly the most important characteristic of the signal voltage. In order to properly display the minute variations in waveform, which incidentally make the difference between good and bad picture quality, the oscilloscope is required to attenuate, amplify, and display voltage changes over an extremely wide frequency range without in any way distorting them. The performance of the Heathkit Model O-12U is entirely adequate for this application.

Again, you must rely upon the manufacturer to furnish representative patterns showing the waveform to be expected at specific test points within the receiver. You will find that these diagrams cover the entire receiver with the exception of the "front-end" or tuner portion. However, in order to pick off the modulation envelope in the IF or video amplifier sections, a demodulator probe is used to make connection to the anode, grid, or cathode of the stage being investigated. This is necessary since the signal in these stages is still contained in the amplitude modulated envelope of the carrier and must be detected, or demodulated, before it can be shown on the oscilloscope. At any point after the video detector, no such probe is necessary and a simple shielded low-capacity cable can be used.

In either case, the signal voltage is fed into the vertical amplifier of the oscilloscope as shown in Figure 37. At any point up to the video detector, the voltages picked off will be quite small, and very little vertical attenuation will be required. Within the sync. circuits and deflection circuits, however, these voltages can be quite high; and considerable attenuation is required. It is for this reason that the vertical input section of the O-12U utilises fully compensated attenuators. Any other method of reducing such voltages would result in enough distortion to render the displayed signal completely useless.

In checking a wave-form, remember that two basic frequencies are involved in the television signal. The vertical or frame frequency is 50 cycles per second. Any investigation of the circuit, except within the horizontal oscillator, its differentiator network, and the horizontal amplifier stages, can generally be made using a time base generator frequency of 16 to 25 cycles, thus showing two or three complete frame wave-forms of the signal. In order to study the line pulse shape, or the operation of the line (horizontal) deflection system, it is generally necessary to operate the time base generator at 10,125 or 5,062.5 cycles per second. This sweep rate will show the wave-form of one or two complete lines of the signal.

The signal-tracer method of analysis is most helpful in going through a receiver in this fashion, since faulty receiver operation is generally caused by the loss of all or a significant portion of the picture information and pulses at some stage within the receiver. With a basic understanding of the function of each part of the signal, and with the means available to determine what the signal actually looks like at any part of the receiver, it is a comparatively simple matter to isolate the defective portion, and the particular component, causing the failure.

Remember, in making connections to the test points, that grid circuits are generally high-impedance points, and that the addition of any capacity can disrupt the performance of the stage to some degree. Anode circuits and cathode circuits are usually lower-impedance points, and more desirable for testing purposes. Also, bear in mind that the anode circuit indication with respect to phase will be exactly opposite to indications obtained on grid or cathode, since a phase difference of 180 degrees takes place within the valve. Therefore, the pattern shown on the scope screen may be inverted when such interchanges are made. The form of the wave will not be changed, however.

3. Video Amplifier response can be measured in exactly the same manner described for testing audio amplifiers, and again a square-wave signal is the most efficient method to use. Because a video amplifier must pass signals from DC to as high as 3.5 megacycles, however, a more comprehensive test is required. Usually a 50 cycle check is made to cover low and medium-frequency characteristics. A second check at 25,000 cycles covers the high-frequency portion of the response curve. Again, such tests require extreme fidelity on the part of the oscilloscope, and these requirements are fully met by the Heathkit model O-12U. The signal-tracing technique can be used in these tests also. The square-wave generator is fed directly into the first video amplifier grid. Very low signal input will be required. The oscilloscope is then connected to various points, starting near the output end and working back until any distortion is isolated. Patterns such as Figure 36B are responsible for poor picture detail, or "fuzziness", while distortion of the form shown in Figure 36C can cause shading of the picture from top to bottom.

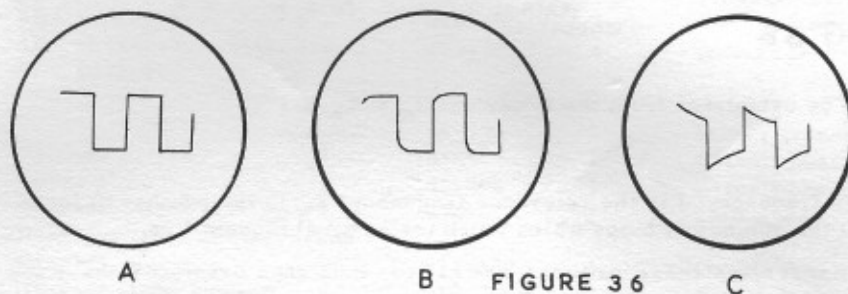

FIGURE 36

Miscellaneous Wave-form Measurements

In this category, we can place such wave-form investigations as measurement of modulation percentage, studies of noise and vibration, sub-sonic and ultra-sonic applications and hundreds of others. Each of these fields is highly specialised, and it is obviously impossible to cover them here. We again refer you to the bibliography for further reading in this field.

AC VOLTAGE MEASUREMENTS

Because of its characteristics, the oscilloscope is particularly suited to the measurement of AC voltages. With the advent of television, it has become imperative that such measurements be made accurately with no regard to wave-shape, so that the conventional RMS reading AC voltmeter is no longer adequate. Most television service bulletins specify peak-to-peak voltages which appear at various points of the circuit. Other applications for such measurements are becoming more common every day.

The O-12U oscilloscope has been designed to accurately measure and display these voltages. Previous instructions have shown how to calibrate the instrument for direct measurement of peak-to-peak wave-forms. The attenuators are especially designed for maximum accuracy, and readings can be relied on to within ± 2 dB when referred to a calibration voltage of the same frequency. An additional error of 1 dB may be encountered when the calibrating voltage and the signal voltage are greatly different in frequency.

When using the graticule for AC voltage measurements, it is sometimes helpful to use the EXT. INPUT setting for the HOR. SELECTOR switch. This produces a vertical line which can be focused and centred exactly for more accurate readings.

The following relationships exist for sine wave-forms:

$$\begin{array}{lcl} \text{RMS} \times 1.414 & = & \text{Peak voltage} \\ \text{RMS} \times 2.828 & = & \text{Peak-to-peak voltage} \end{array} \qquad \begin{array}{lcl} \text{Peak voltage} \times 0.707 & = & \text{RMS voltage} \\ \text{Peak-to-peak voltage} \times 0.3535 & = & \text{RMS voltage} \end{array}$$

AC CURRENT MEASUREMENTS

To measure AC currents, the unknown current must be passed through a resistor of known value. The voltage drop across this resistor is measured as described earlier. From Ohm's law, I equals E/R , the current can be calculated. It is important that the resistor be non-reactive at the frequency involved. It should also be relatively small with respect to the resistance of the load.

FREQUENCY MEASUREMENTS

Frequency measurements can be made with an accuracy limited only by the reference frequency source available. The unknown frequency is applied to the vertical input, and the reference frequency to the horizontal input. (Time base generator is not used.) The resultant pattern may take on any one of a number of shapes. Typical patterns are shown below.

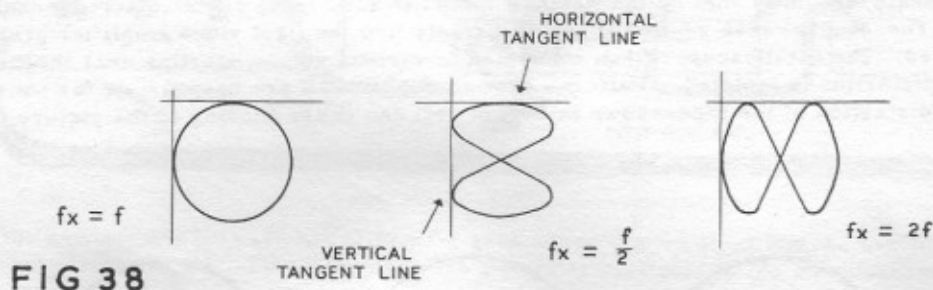

FIG 38

The frequency ratio can be calculated from the formula: $f_x = \frac{T_h \times f}{T_v}$

Where f_x is the unknown frequency; f is the reference frequency; T_h is the number of loops which touch the horizontal tangent line; T_v is the number of loops which touch the vertical tangent line.

When using Lissajous figures, as these patterns are called, it is good practice to have the figure rotating slowly rather than stationary. This eliminates the possibility of an error in counting the tangent points. If the pattern is stationary, a double image similar to the figure below may be formed. In such cases, the end of the trace should be counted as one-half a tangent point rather than a full point. This condition may occur when neither frequency can be varied.

PHASE MEASUREMENTS

It is sometimes necessary to determine the phase relationship between two AC voltages of the same frequency. This can be accomplished quite easily by applying one of the voltages to the horizontal input and the other voltage to the vertical input. The phase relationship can be estimated from the figures below.



FIGURE 39

To calculate the phase relationship, use the following formula: $\sin \theta = \frac{A}{B}$

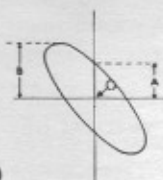

FIG40

The distance A is measured from the X axis to the intercept point of the trace and the Y axis. The distance B represents the height of the pattern above the X axis. The axes of the ellipse must pass through the point O .

PARTS LIST

PART No.	PARTS Per Kit	DESCRIPTION	PART No.	PARTS Per Kit	DESCRIPTION
Hardware			Potentiometers - Switches (cont'd.)		
250-512	4	2BA x 1/2" binder head screw	10-507	1	20 KΩ linear, centre tapped potentiometer
250-511	4	2BA x 3/8" binder head screw	10-512	1	7.5 megohm linear potentiometer
250-510	2	2BA x 5/8" binder head screw, chrome plated	10-505	1	2 KΩ linear potentiometer w/dummy tag
250-514	9	4BA x 3/8" binder head screw, chrome plated	19-502	1	500 KΩ potentiometer, linear, HV insulated shaft and DPST switch
250-9	14	4BA x 3/8" binder head screw	63-47	1	1 sec. 3-position rotary switch
250-515	2	4BA x 3/4" binder head screw	63-87	1	1 sec. 7-position rotary switch
250-502	21	6BA x 5/16" binder head screw	63-88	1	1 sec. 4-position rotary switch
250-520	2	6BA x 3/4" binder head screw	Insulators - Feet		
252-503	10	2BA hex nut	73-501	3	3/8" grommet
252-3	25	4BA hex nut	73-502	3	5/8" grommet
252-501	22	6BA hex nut	73-505	1 length	Cushion strip
254-502	10	2BA lockwasher	320-501	1 length	Foam plastic strip
254-1	25	4BA lockwasher	261-501	4	Rubber feet
254-501	23	6BA lockwasher	Miscellaneous		
259-504	8	4BA shakeproof solder tag	54-503	1	Power transformer
255-502	2	6BA spacers	85-503	1	Circuit board, front
Sheet Metal Parts			85-502	1	Circuit board, rear
90-501	1	Cabinet	432-504	1	CRT anode connector comprising rubber insulator with socket insert
205-504	1	Cover plate	211-501	1	Handle with 2 end plates
200-502	1	Chassis, steel zinc plated	260-1	2	Crocodile clip
203-501	1	Panel, painted and screened	414-501	1	Graticule
204-502	2	Bracket, angle	481-502	1	Mounting plate, for electrolytic capacitor
204-503	1	Bracket, tube support	595-504	1	Instruction manual
206-M28	1	Shield, top	Resistors		
206-M29	1	Shield, bottom	H-620C5	1	62Ω 1/2 watt 5%
207-503	2	Clamp, CR tube	H-101C10	5	100Ω 1/2 watt 10%
210-501	1	Panel ring	H-221C10	3	220Ω 1/2 watt 10%
258-502	1	Spring retainer for graticule	H-471C10	1	470Ω 1/2 watt 10%
Valveholders - Sockets			H-821C10	1	820Ω 1/2 watt 10%
434-503	1	Octal valveholder	H-102C10	1	1 KΩ 1/2 watt 10%
434-508	1	Pilot lamp socket	H-202C10	2	2 KΩ 1/2 watt 10%
434-507	1	B14A CRT socket	H-222C5	3	2.2 KΩ 1/2 watt 5%
434-59	3	7-pin miniature valveholder	H-272C10	1	2.7 KΩ 1/2 watt 10%
434-60	5	9-pin miniature valveholder	H-332C10	3	3.3 KΩ 1/2 watt 10%
Tagstrips - Panel			H-392C10	2	3.9 KΩ 1/2 watt 10%
431-1	2	1-way tagstrip	H-682C10	1	6.8 KΩ 1/2 watt 10%
431-2	1	2-way tagstrip	H-103C10	3	10 KΩ 1/2 watt 10%
431-10	1	3-way tagstrip	H-153C10	1	15 KΩ 1/2 watt 10%
431-12	2	4-way tagstrip	H-223C10	2	22 KΩ 1/2 watt 10%
431-506	2	7-way tagstrip	H-333C10	2	33 KΩ 1/2 watt 10%
605-501	1	Voltage selector panel	H-363C5	1	36 KΩ 1/2 watt 5%
Potentiometers - Switches			H-473C10	1	47 KΩ 1/2 watt 10%
10-506	1	10 KΩ linear potentiometer	H-104C10	3	100 KΩ 1/2 watt 10%
10-508	1	200 KΩ linear, centre tapped potentiometer	H-154C10	2	150 KΩ 1/2 watt 10%
10-509	1	250 KΩ linear potentiometer	H-334C5	1	330 KΩ 1/2 watt 5%
10-510	1	1 megohm linear potentiometer	H-474C10	4	470 KΩ 1/2 watt 10%
10-513	1	2 megohm linear potentiometer	H-684C10	1	680 KΩ 1/2 watt 10%
10-511	1	2 megohm linear potentiometer, HV insulated shaft	H-105C10	2	1 megohm 1/2 watt 10%

PARTS LIST (Cont'd.)

PART No.	PARTS Per Kit	DESCRIPTION	PART No.	PARTS Per Kit	DESCRIPTION
Resistors (cont'd.)			Capacitors, electrolytic		
H-335C10	2	3.3 megohm $\frac{1}{2}$ watt 10%	25-506	1	40-20-20 μ F 450 volt, 50 μ F 300 volt
H-475C10	2	4.7 megohm $\frac{1}{2}$ watt 10%	25-507	1	40-40-20 μ F 275 volt
H-106C10	3	10 megohm $\frac{1}{2}$ watt 10%	25-28	1	100 μ F 50 volt
H-226C10	1	22 megohm $\frac{1}{2}$ watt 10%	25-20	2	40 μ F 150 volt
1-102C10	2	1 K Ω 1 watt 10%	Coils		
1-152C10	1	1.5 K Ω 1 watt 10%	45-12	2	33 μ H (on 3.3 K Ω 1 watt resistor \pm 10%)
1-333C10	2	33 K Ω 1 watt 10%	45-23	2	61 μ H (red band)
1-104C10	1	100 K Ω 1 watt 10%	45-24	2	90 μ H (blue band)
1-474C10	1	470 K Ω 1 watt 10%	45-25	1	30 μ H (green band)
1-684C10	1	680 K Ω 1 watt 10%	Wire-Cable		
1-335C10	1	3.3 megohm 1 watt 10%	331-501	1 length	Solder, 18 swg.
2-122C10	1	1.2 K Ω 2 watt 10%	331-502	1 length	Solder, 22 swg.
2-272C10	2	2.7 K Ω 2 watt 10%	340-501	1 length	Tinned copper wire
2-472C10	1	4.7 K Ω 2 watt 10%	344-506	1 length	Connecting wire
2-123C10	1	12 K Ω 2 watt 10%	341-1	1 length	Black test lead wire
H-335HS5	1	3.3 megohm $\frac{1}{2}$ watt 5% precision	341-2	1 length	Red test lead wire
8-102W5	1	1 K Ω 8 watt \pm 5% wirewound	89-501	1 length	Mains cable
8-502W5	1	5 K Ω 8 watt \pm 5% wirewound	100-501	1	Cable assembly
Capacitors, tubular			347-2	1 length	300 Ω transmission line
23-504	2	.05 μ F 250 volt	346-501	1 length	Sleeving 1.5 m. m.
23-505	7	.1 μ F 250 volt	Valves - Rectifier - Lamp		
23-58	2	.2 μ F 200 volt	411-4	1	6C4
23-3	1	.01 μ F 400 volt	411-25	3	ECC82 (12AU7)
23-502	1	.1 μ F 400 volt	411-505	1	Cathode ray tube 1324C
23-63	3	.25 μ F 400 volt	411-58	1	EC92
23-11	1	.1 μ F 600 volt	411-504	1	GZ34
23-506	2	.1 μ F 2000 volt	411-502	1	ECF80
Capacitors, mica			411-73	1	12BH7
20-508	1	47 pF \pm 10% 350 volt	411-79	1	6J6
20-509	1	390 pF \pm 10% 350 volt	57-501	1	Selenium rectifier K8/50
31-501	1	25 and 250 pF dual trimmer	412-501	1	Pilot lamp 6.3 volt .15 amp
Capacitors, ceramic disc			Knobs - Plugs - Terminals		
21-505	1	10 pF 500 volt	462-18	4	Knob, without skirt
21-506	1	20 pF 500 volt	462-19	8	Knob, with skirt and index line
21-507	1	200 pF 500 volt	70-5	1	Black wander plug
21-508	1	500 pF 500 volt	70-6	1	Red wander plug
21-509	1	1000 pF 500 volt	438-502	1	1 amp fused plug
21-510	1	.002 μ F 500 volt	427-502	5	Terminal, black
21-511	1	.01 μ F 500 volt	427-501	2	Terminal, red
21-512	1	.02 μ F 500 volt			
21-513	2	.02 μ F 2000 volt			

GUARANTEE

Daystrom Limited guarantee subject to the following terms to repair or replace free of charge any defective parts of this Heathkit (with the exception of cathode ray tubes and valves referred to hereunder) which fail owing to faulty workmanship or material provided the defective parts are returned to Daystrom Limited within 12 months from date of purchase:—

1. This guarantee is given to and for the benefit of the original buyer only, and is and shall be in lieu of, and there is hereby expressly excluded, all other guarantees, conditions or warranties, whether express or implied, statutory or otherwise, as to quality or fitness for any purpose of the equipment, and in no event shall Daystrom Limited be liable for any loss of anticipated profits, damages, consequential or otherwise, injury, loss of time or other losses whatsoever incurred or sustained by the buyer in connection with the

purchase, assembly or operation of Heathkits or components thereof.

2. No replacement will be made of parts damaged by the buyer in the course of handling, assembling, testing or operating Heathkit equipment.

3. The purchaser shall comply with the Replacements Procedure laid down in the relevant Heathkit Manual.

4. Daystrom Limited will not replace, repair or service instruments or parts thereof in which acid core solder or paste fluxes have been used and in such event this guarantee shall be completely void.

Note: The Cathode Ray Tubes and Valves forming part of the equipment are guaranteed by the respective manufacturers. It should be noted that their guarantee is given only in respect of faulty workmanship and/or material and does not cover misuse or consequential damage.

Heathkit

HELPFUL KIT BUILDING INFORMATION

Before attempting actual kit construction read the construction manual thoroughly to familiarise yourself with the general procedure. Note the relative location of pictorial inserts in respect of the progress of the assembly procedure outlined. This information is offered primarily for the convenience of the novice kit builders and will be of definite assistance to those lacking thorough knowledge of good construction practices. Even the advanced electronic enthusiast may benefit by a brief review of this material before proceeding with kit construction. In the majority of cases, failure to observe basic instruction fundamentals is responsible for inability to obtain desired level of performance.

RECOMMENDED TOOLS

The successful construction of Heathkits does not require the use of specialised equipment and only basic tools are required. A good quality electric soldering iron is essential. The preferred size would be a 25-50 watt iron with a small tip. The use of long nose pliers and a diagonal or side cutting pliers is recommended. A small screw driver will prove adequate and several additional assorted screw drivers will be helpful. Be sure to obtain a good supply of resin core type radio solder. Never use separate fluxes, paste or acid solder in electronic work.

ASSEMBLY

In the actual mechanical assembly of components to the chassis and panel, it is important that the procedure shown in the manual be carefully followed. Make sure that the valve holders are properly mounted in respect to keyway or pin numbering location. The same applies to transformer mountings so that the correct transformer colour coded wires will be available at the proper chassis opening. Make it a standard practice to use lockwashers under all 4BA and 2BA nuts. The only exception being in the use of soldering tags - the necessary locking feature is already incorporated in the design of the soldering tags. A control lock washer should always be used between the control and the chassis to prevent undesirable rotation in the panel. To improve instrument appearance and to prevent possible panel marring use a control flat nickel washer under each control nut.

When installing terminals that require the use of fibre insulating washers, it is good practice to slip the shouldered washer over the terminal stud before installing the mounting stud in the panel hole provided. Next, install a flat fibre washer and a soldering tag under the mounting nut. Be sure that the shouldered washer is properly centred in the panel to prevent possible shorting of the terminal.

WIRING

When following the wiring procedure make the leads as short and direct as possible. In filament wiring requiring the use of a twisted pair of wires allow sufficient slack in the wiring that will permit the twisted pair to be pushed against the chassis as closely as possible thereby affording relative isolation from adjacent parts and wiring.

When removing insulation from the end of connecting wire, it is seldom necessary to expose more than a quarter inch of the wire. Excessive insulation removal may cause a short circuit condition in respect of nearby wiring or terminals. In some instances, transformer leads of solid copper will have a brown baked enamel coating. After the transformer leads have been trimmed to a suitable length, it is necessary to scrape the enamel coating in order to expose the bright copper wire before making a terminal or soldered connection. In mounting parts such as resistors or capacitors, trim off all excess lead lengths so that the parts may be installed in a direct point-to-point manner. When necessary use insulated sleeving over exposed wires that might short to nearby wiring. It is urgently recommended that the wiring and parts layouts shown in the construction manual be faithfully followed. In every instance the desirability of this arrangement was carefully determined following the construction of a series of laboratory models.

SOLDERING

Much of the performance of the kit instrument, particularly in respect of accuracy and stability, depend upon the degree of workmanship used in making soldered connections. Properly soldered connections are not at all difficult to make but it would be advisable to observe a few precautions. First of all before a connection is to be soldered, the connection itself should be clean and mechanically strong. Do not depend on solder alone to hold a connection together. The tip of the soldering iron should be bright, clean and free of excess solder. Use enough heat so that the solder flows thoroughly and smoothly into the joint. Avoid excessive use of solder and do not allow a flux flooding condition to occur which could conceivably cause a leakage path between adjacent terminals on switch assemblies and valve holders. This is particularly important in instruments such as the VVM, oscilloscope and generator kits. Excessive heat will also burn or damage the insulating material used in the manufacture of switch assemblies. Be sure to use only good quality resin core type solder.

AERIAL		CAPACITOR (VARIABLE)		SWITCH — SINGLE POLE (S.P.) SINGLE THROW (S.T.)		BATTERY	
LOOP		RESISTOR		SWITCH — DOUBLE POLE (D.P.) DOUBLE THROW (D.T.)		FUSE	
DIPOLE		RESISTOR (TAPPED)		SWITCH — TRIPLE POLE (T.P.) DOUBLE THROW (D.T.)		CRYSTAL	
EARTH		RESISTOR (VARIABLE)		LOUDSPEAKER		TERMINAL & TERMINAL STRIP	
INDUCTOR (COIL OR R.F. CHOKE)		POTENTIOMETER		RECTIFIER		WIRING BETWEEN LIKE LETTERS IS UNDERSTOOD	
R.F. COIL WITH ADJUSTABLE IRON DUST CORE		JACK (TWO CONDUCTOR)		MICROPHONE		MICRO (x 1/1,000,000) = μ	
L.F. CHOKE (IRON CORED) WITH TAPPINGS		JACK (THREE CONDUCTOR)		TYPICAL TUBE SYMBOL		MILLI (x 1/1000) = m	
R F TRANSFORMER (AIR CORE)		WIRES CONNECTED		TRANSISTOR (P.N.P. TYPE)		KILO (x 1000) = K	
TRANSFORMER (R.F. or ADJUSTABLE I.F. IRON DUST CORE)		WIRES CROSSING BUT NOT CONNECTED		TRANSISTOR (N.P.N. TYPE)		MEGA (x 1,000,000) = M	
TRANSFORMER (MAINS OR L.F.) IRON CORE		A-AMMETER V-VOLTMETER mA-MILLIAMMETER μA-MICROAMMETER ETC.		TRANSISTOR (N.P.N. TYPE)		OMEGA (OHMS) = Ω	
CAPACITOR		NEON LAMP STABILISER VALVE		SOCKET-OUTLET CO AXIAL		MICROFARAD = μF	
CAPACITOR (ELECTROLYTIC)		LAMP PILOT OR ILLUMINATING		TWO PIN SOCKET AND TWO PIN PLUG		PICOFARAD = pF MICRO-MICROFARAD = μμF	

DAYSTROM LIMITED

A Member of the Daystrom Group

THE WORLDS LARGEST MANUFACTURERS
OF ELECTRONIC KITS

GLOUCESTER, ENGLAND